

# S SOLANELLAS



**jandel**

CATÁLOGO  
2023

Manillas  
y complementos  
para puertas



**jandel**

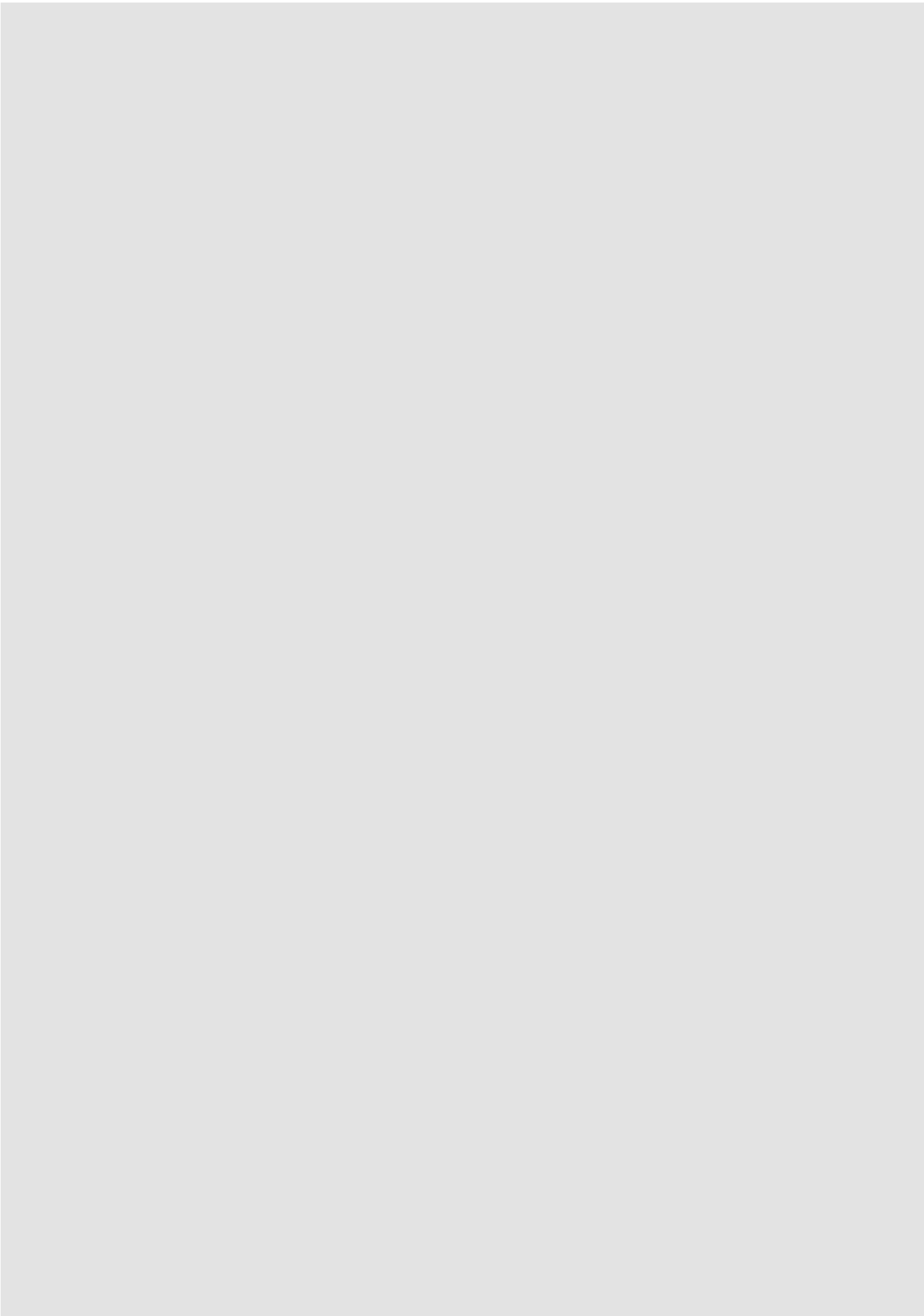



# ¡ Bienvenido a casa !

Diferentes estilos

Diferentes necesidades

Diferentes series

UNA MISMA MARCA





## DISEÑO FABRICACIÓN DISTRIBUCIÓN

Jandel presenta su nuevo catálogo ampliando su gama de productos, manivelas, manillones, pomos, tiradores y complementos de alta calidad, siguiendo las tendencias del mercado. El detalle es siempre importante y es ahí donde se aprecia la sensibilidad de quien crea, la manivela en una puerta nos permite abrirla, un gran compromiso y complicidad con la arquitectura es lo que la firma Jandel tiene desde sus inicios, una empresa dedicada al amplio sector de la ferretería y con una extensa experiencia.



**CERTIFICADO DE CALIDAD ISO 9001-20158**

ISO significa calidad, confianza, confianza, seguridad y muchos otros valores positivos para nuestros clientes. Es una norma de sistemas de gestión de la calidad. La norma más reconocida y establecida a nivel mundial de gestión de la calidad. En Jandel estamos orgullosos de formar parte de esta organización. Una metodología única que permite a gestionar a Jandel sus sistemas y sus riesgos de manera más eficiente para proteger sus futuros resultados. Ayuda a Jandel a cumplir con las expectativas y necesidades de sus clientes, entre otros beneficios. Las manillas, manillones, pomos, complementos para puertas y tiradores de Jandel están en buenas manos.



## **CUIDAMOS NUESTRO PLANETA**

### **GESTIÓN DE RESIDUOS**

La gestión de residuos, es la recolección, transporte, procesamiento o tratamiento, reciclaje o disposición de material de desecho, generalmente producida por la actividad humana, en un esfuerzo por reducir los efectos perjudiciales en la salud humana y la estética del entorno, aunque actualmente se trabaja no solo para reducir los efectos perjudiciales ocasionados al medio ambiente sino para recuperar a los recursos del mismo.

### **DESENGRASE DE METÁLES**

Para las industrias en las que el proceso de producción incluye la fabricación o montaje de componentes metálicos, es fundamental un limpieza efectiva de grasas, aceites, taladrinas, desmoldeantes, etc. Nuestros artículos pasan por diferentes equipos para realizar esta operación, siempre con lavado de agua y productos biodegradables.



## CUIDAMOS LOS DETALLES

### EMBALAJE ECOLÓGICO

Conscientes de la problemática que representan los residuos en el medio ambiente, el packaging de nuestros artículos es respetuoso con el medio ambiente.

Jandel insiste en el uso de embalajes ecológicos para sus productos. Para conseguirlo, ha implementado el uso de materiales reciclados y reciclables, reducido el tamaño de las cajas de los productos y aumentando el uso de embalajes masivos.

JANDEL PREMIUM	
Manivelas .....	14
Bases.....	27
Grisanes .....	28
Manillones .....	29
Alzantes.....	32
Complementos .....	34

JANDEL ORIGINAL	
Manivelas .....	42
Bases.....	71
Manillones .....	72
Grisanes .....	80
Pomos de puerta .....	82
Complementos .....	86

JANDEL EQUAL	
Manivelas .....	94
Manillones .....	112
Complementos .....	122
Accesorios Técnicos.....	131

JANDEL INOX	
Manivelas .....	133
Manillones .....	138
Complementos .....	146
Pomos .....	149

JANDEL TIRADORES MUEBLE.....	150
------------------------------	-----



# INDICE

## JANDEL PREMIUM

 <b>NEW</b> 1301 ..... 14	 <b>NEW</b> 3310 ..... 19	 6318 ..... 25	 <b>NEW</b> C338 ..... 31	 38BY ..... 36
 <b>NEW</b> 1311 ..... 14	 3327 ..... 19	 6328 ..... 25	 <b>NEW</b> 102AL2 ..... 32	 38BO ..... 36
 1320 ..... 14	 3337 ..... 20	 6338 ..... 26	 <b>NEW</b> 359AL2 ..... 32	 38WC ..... 36
 <b>NEW</b> 1327 ..... 15	 3357 ..... 21	 6347 ..... 26	 <b>NEW</b> 168AL2 ..... 33	 39BY ..... 36
 1348 ..... 16	 3367 ..... 21	 BASES ..... 27	 13BY ..... 34	 39BO ..... 36
 1356 ..... 16	 3377 ..... 21	 CG66 ..... 28	 13BO ..... 34	 39WC ..... 36
 1358 ..... 16	 3378 ..... 22	 CG20 ..... 28	 13WC ..... 34	 63BY ..... 37
 1366 ..... 17	 3388 ..... 23	 G88C ..... 28	 <b>NEW</b> MARIONWC ..... 34	 63BO ..... 37
 <b>NEW</b> 1369 ..... 17	 3398 ..... 23	 C349 ..... 29	 33BY ..... 35	 63WC ..... 37
 <b>NEW</b> 1379 ..... 17	 3720 ..... 23	 EQ-M802 ..... 29	 33BO ..... 35	 01WC ..... 37
 1388 ..... 18	 3766 ..... 24	 C327 ..... 29	 33WC ..... 35	 03WC ..... 37
 1397 ..... 18	 3887 ..... 24	 <b>NEW</b> C379 ..... 30	 37BY ..... 35	 CXBY ..... 38
 1398 ..... 18	 <b>NEW</b> 3889 ..... 24	 <b>NEW</b> C369 ..... 30	 37BO ..... 35	 CXBO ..... 38
 <b>NEW</b> 1399 ..... 19	 3976 KUBO ..... 25	 <b>NEW</b> C348 ..... 31	 37WC ..... 35	 CXBYC ..... 38

JANDEL ORIGINAL

				
CXBOC..... 38	1023..... 42	1224..... 45	KAROL..... 48	SV-R950..... 53
				
C630..... 39	1045..... 42	1229..... 45	EQ-R657..... 49	SV-C650..... 53
				
C635..... 39	1059..... 42	1234..... 45	EQ-R653..... 49	SV-C950..... 53
				
7610..... 39	1072..... 42	1239..... 45	EQ-R207..... 49	3012..... 54
				
7630..... 39	1075..... 42	1249..... 45	EQ-R208..... 49	3022..... 54
				
75220..... 40	1080..... 42	1254..... 45	EQ-R209..... 49	3070..... 54
				
75200..... 40	1082..... 43	12TE..... 46	EQ-R450..... 49	3080..... 54
				
75420..... 40	1090..... 43	15TE..... 46	EQ-R890..... 50	3082..... 54
				
75400..... 40	1092..... 43	WCTE..... 46	EQ-R891..... 50	3413..... 54
				
9510..... 41	1105..... 43	HQTE..... 46	EQ-R892..... 50	3424..... 55
				
9530..... 41	1115..... 44	H2TE..... 46	UOVO..... 52	3429..... 55
				
1209..... 44	1264..... 48	POLO PORCELANA..... 52	3434..... 55	
				
1213..... 44	2040..... 48	POLO..... 52	3449..... 55	
				
1219..... 44	6042..... 48	SV-R650..... 53	3570..... 57	



# JANDEL ORIGINAL

 4513..... 57	 EQ-796..... 62	 PLACAS..... 71	 C327..... 76	 C209..... 85
 SV-PC65..... 57	 EQ-1599..... 62	 C302..... 72	 C322..... 77	 C605..... 86
 SVP650..... 57	 EQ-2733..... 63	 EQ-M890..... 72	 C326..... 77	 C606..... 86
 3223..... 58	 EQ-3800..... 63	 EQ-M891..... 72	 C359..... 79	 SV-BR25..... 86
 EQ-9690..... 58	 EQ-4402..... 64	 EQ-M892..... 72	 C800..... 79	 EQ-285Z..... 86
 EQ-9691..... 58	 EQ-4406..... 64	 C307..... 73	 CG75..... 80	 C608..... 87
 EQ-9692..... 58	 EQ-4419..... 65	 C308..... 73	 CGKA..... 80	 SV-CR50..... 87
 8045..... 59	 EQ-4423..... 66	 C309..... 73	 G13C..... 81	 C630..... 87
 1605..... 59	 EQ-4424..... 66	 C310 / C312..... 73	 SV-105P..... 82	 12BY..... 87
 4459..... 59	 EQ-4450..... 67	 C311..... 74	 C207..... 82	 SV-495..... 88
 EQ-100B..... 60	 EQ-8300..... 67	 C313..... 74	 C208..... 82	 C611..... 89
 EQ-297..... 60	 EQ-9500..... 68	 C316..... 74	 EQ-1085..... 83	 34BY..... 89
 EQ-330..... 61	 EQ-9501..... 68	 C320..... 75	 EQ-1095..... 83	 C635..... 89
 EQ-525..... 61	 EQ-9600..... 69	 C349..... 75	 C210..... 84	 C902..... 89

## JANDEL EQUAL



**12WC** ..... 90



**C621** ..... 90



**34WC** ..... 90



**SV-CC35** ..... 90



**7610** ..... 91



**7630** ..... 91



**7510** ..... 91



**7530** ..... 91



**C410** ..... 92



**C420** ..... 92



**C450** ..... 92



**C460** ..... 92



**T490-91-92** ..... 93



**A490-91-92** ..... 93



**EQ-202** ..... 94



**EQ-203** ..... 94



**EQ-204** ..... 94



**EQ-205** ..... 94



**EQ-206** ..... 95



**EQ-207** ..... 95



**EQ-208** ..... 95



**EQ-209** ..... 95



**EQ-210** ..... 96



**EQ-868** ..... 96



**EQ-R204** ..... 99



**EQ-R150** ..... 99



**EQ-R200** ..... 99



**EQ-R250** ..... 99



**SV-R300** ..... 100



**SV-R333** ..... 100



**SV-R350** ..... 100



**SV-R600** ..... 100



**SV-R700** ..... 101



**SV-R800** ..... 101



**SV-R850** ..... 101



**SV-R655** ..... 101



**EQ-C150** ..... 102



**EQ-C200** ..... 102



**EQ-C350** ..... 102



**EQ-C400** ..... 102



**EQ-C700** ..... 102



**EQ-C750** ..... 102



**SV-P150** ..... 106



**SV-P200** ..... 106



**SV-P250** ..... 106



**SV-P300** ..... 106



**SV-P333** ..... 106



**SV-P350** ..... 107



**SV-P600** ..... 107



**SV-P850** ..... 107



**SV-P700** ..... 107



**SV-PC20** ..... 108



**SV-PC35** ..... 108



**SV-PC70** ..... 108



**SV-PC75** ..... 108



**SV-P400** ..... 108



**SV-P398** ..... 110



**SV-P500** ..... 110



**SV-PP50** ..... 110



**SV-M500** ..... 110



**SV-M150** ..... 112



**SV-M350** ..... 112



**SV-M200** ..... 112



**SV-M335** ..... 113



**EQ-M802** ..... 113



**SV-M600** ..... 113



**SV-MC15** ..... 114



**SV-MC20** ..... 114



































































**SV-MC35** ..... 114



**SV-M400** ..... 114

# JANDEL EQUAL

 EQ-M800..... 116	 SV-495..... 122	 SV-CCDC..... 125	 SV-A401..... 127	 BH-90RI..... 129
 EQ-M810..... 116	 EQ-1197..... 122	 SV-KITC..... 125	 PH-100D (DER.)... 128	 BI-90CD (DER.)... 129
 EQ-M831..... 116	 SV-BC15..... 123	 KITC20..... 125	 PH-100I (IZQ.)... 128	 BI-90CI..... 129
 EQ-M861..... 116	 SV-BC25..... 123	 PICOLORO..... 125	 PH-95D (DER.)... 128	 BI-80CD (DER.).. 129
 SV-M360..... 119	 SV-B303..... 123	 SV-KITB..... 126	 PH-95I (IZQ.)... 128	 BI-80CI..... 129
 EQ-M802K..... 119	 SV-B308..... 123	 SV-KITC..... 126	 PI-100D (DER.)... 128	 BI-90RD (DER.)... 129
 SV-MP15..... 120	 SV-CC35..... 123	 PU-47/PU-70... 126	 PI-100I (IZQ.)... 128	 BI-90RD (IZQ.)... 129
 SV-PP15..... 120	 SV-CC50..... 123	 SV-PSMN..... 126	 PI-95D (DER.)... 128	 SV-PR..... 130
 SV-C150..... 120	 C902..... 123	 MR-2542..... 127	 PI-95I (IZQ.)... 128	 SV-PC..... 130
 EQ-285Z..... 122	 SVDEDALC..... 124	 MR-3560..... 127	 BH-90CD (DER.) . 129	<b>ACCESORIOS TÉCNICOS..... 131</b>
 SV-BR25..... 122	 SVDEDALR..... 124	 SV-TOPE..... 127	 BH-90CI..... 129	
 SV-B304..... 122	 SV-CCDR..... 124	 SV-T150..... 127	 BH-80CD (DER.) . 129	
 SV-B305..... 122	 SV-KITR..... 124	 SV-A150..... 127	 BH-80CI..... 129	
 SV-CR50..... 122	 KITR20..... 124	 SV-T401..... 127	 BH-90RD..... 129	

# INDICE

## JANDEL INOX

				
SV-R302..... 133	SV-X338..... 135	SV-M318..... 138	EQ-M810..... 144	SV-B303..... 147
				
SV-X302..... 133	SV-G338..... 135	SV-M338..... 138	EQ-M831..... 144	SV-B308..... 147
				
SV-G302..... 133	SV-P338..... 135	SV-M258..... 138	EQ-M801..... 145	SV-B306..... 147
				
SV-F302..... 133	SV-P339..... 135	SV-M365..... 138	EQ-M802..... 145	SV-1198..... 147
				
SV-E302..... 133	SV-R318 / SV-R358... 136	SV-M360..... 138	EQ-M802K..... 145	HUELLA15..... 147
				
SV-P301..... 133	SV-P318..... 136	SV-MP32..... 139	SV-340..... 146	HUELLA20..... 147
				
SV-P302..... 133	SV-P319..... 136	SV-PP32..... 139	SV-345..... 146	TOPE INOX..... 147
				
SV-R336..... 134	SV-C334..... 136	SV-LP30..... 139	SV-348..... 146	SV-8510..... 148
				
SV-X336..... 134	SV-P334..... 136	SV-MF32..... 139	SV-B304..... 146	EQ-8610..... 148
				
SV-G336..... 134	SV-R258..... 137	SV-LF30..... 139	SV-B305..... 146	SV-170P..... 149
				
SV-F336..... 134	SV-P258..... 137	EQ-M861..... 140	SV-B307..... 146	SV-172P..... 149
				
SV-P336..... 134	SV-C413..... 137	EQ-M851..... 142	SV-B309..... 146	
				
SV-P337..... 134	SV-P413..... 137	EQ-M841..... 143	SV-346..... 147	
				
SV-R338..... 135	SV-M302..... 138	EQ-M800..... 144	SV-347..... 147	

# JANDEL TIRADORES

			
M04 ..... 150	M24 ..... 152	H112 ..... 156	H132 ..... 159
			
M26 ..... 150	M25 ..... 152	H115 ..... 156	H133 ..... 159
			
M27 ..... 150	M26 ..... 152	H120 ..... 156	H134 ..... 159
			
M28 ..... 150	H55 ..... 154	H121 ..... 156	H135 ..... 159
			
M03 ..... 150	H76 ..... 154	H122 ..... 156	H136 ..... 160
			
M07 ..... 150	H93 ..... 154	H123 ..... 157	H137 ..... 160
			
M09 ..... 150	H94 ..... 154	H124 ..... 157	H138 ..... 160
			
M10 ..... 151	H95 ..... 154	H125 ..... 157	H140 ..... 160
			
M11 ..... 151	H102 ..... 154	H126 ..... 158	SV-HUELLA ... 160
			
M12 ..... 151	H103 ..... 154	H127 ..... 158	
			
M13 ..... 151	M113 ..... 154	M128 ..... 158	
			
M14 ..... 151	H107 ..... 155	H129 ..... 159	
			
M22 ..... 152	H108 ..... 155	H130 ..... 159	
			
M23 ..... 152	H111 ..... 155	H131 ..... 159	

**LEYENDA DE  
ACABDOS.....161**



NEW

### 1301 Plana ZK

Opciones	Ref.	ANTR	CB	CI	CS	NE	NM		
Ø50  5	1301							1	24
247  45	2301							1	12



NEW

### 1311 Cloe LAT

Opciones	Ref.	CB	CS	NE	PB		
Ø50  5	1311					1	16
247  45	2311					1	12









### 1320 Shape AL

Opciones	Ref.	ANTR	BL	CO.ST	EFCs	EFLM	NE	NM.OP		
Ø50  5	1320								1	24
247  45	2320								1	12



NEW

1327 Corsa ZK





Opciones	Ref.	ANTR	BL	CB	CS	NE	NM	NM.OP		
Ø50  5 	1327								1	16
247  45 	2327								1	12



-  ANTR Antracita
-  CI Cuero Inglés
-  CS Cromo Satin. EFCS
-  INOX
-  NMM Níquel Mate Mate
-  PB Pulido Brillo
-  BL Blanco
-  CO.ST Cobre Satin.
-  Efect. Cromo Satin.
-  LM Latón Mate
-  NMOP Níquel Mat. Opaco
-  PL Plata
-  CB Cromo Brillo
-  CU Cuero
-  EFLM Efect. Latón Mate
-  NM Níq. Mate
-  NE Negro
-  PL. AN Plata Anodizada







### 1348 Marina New ZK

Opciones	Ref.	CB	PL		
Ø50  5 	<b>1348</b>			1	16
247  45	<b>2348</b>			1	12







### 1356 Easy ZK

Opciones	Ref.	CB	CI	CS	NM		
Ø50  5 	<b>1356</b>					1	16
247  45	<b>2356</b>					1	12



### 1358 Altwien LAT

Opciones	Ref.	CB	PB		
Ø50  5 	<b>1358</b>			1	16
247  45	<b>2358</b>			1	12





**1366 Olanda** INOX

Opciones	Ref.	ANTR	BL	CB	EFLM	INOX	NE		
Ø50  5	<b>1366</b>							1	24
247  45	<b>2366</b>							1	12



NEW

**1369 Marion** LAT

Opciones	Ref.	CB	CI	LM	NE	NM	PB		
Ø50  5	<b>1369</b>							1	16
247  45	<b>2369</b>							1	12



NEW







**1379 Inés** LAT

Opciones	Ref.	BL	CB	CI	CS	LM	NE	NM	PB		
Ø50  5	<b>1379</b>									1	16
247  45	<b>2379</b>									1	12

- ANTR Antracita
- CI Cuero Inglés
- CS Cromo Satin. EFCS
- INOX
- NMM Níquel Mate Mate
- PB Pulido Brillo
- BL Blanco
- CO.ST Cobre Satin.
- Efect. Cromo Satin.
- LM Latón Mate
- NMOP Níquel Mat. Opaco
- PL Plata
- CB Cromo Brillo
- CU Cuero
- EFLM Efect. Latón Mate
- NM Níq. Mate
- NE Negro
- PL. AN Plata Anodizada









**1388 Ice** ZK

Opciones	Ref.	ANTR	BL	CB	CI	CS	NE	NM	NM.OP		
Ø50  5 	<b>1388</b>									1	16
247  45 	<b>2388</b>									1	12









**1397 Adelle** ZK

Opciones	Ref.	CB	CI	CS	NE	NM		
Ø50  5 	<b>1397</b>						1	16
247  45 	<b>2397</b>						1	12



**1398 Slim** ZK

Opciones	Ref.	ANTR	BL	CB	CS	NE	NM	NM.OP		
Ø50  5 	<b>1398</b>								1	16
247  45 	<b>2398</b>								1	12



NEW

1399 Punto ZK

Opciones	Ref.	ANTR	CB	CS	NE	NM		
Ø50  5	1399						1	16
247  45	2399						1	12



NEW

3310 Origami ZK

Opciones	Ref.	ANTR	BL	CB	CS	NE	NM		
50X50  5	3310							1	16
248  40	4310							1	12







3327 Corsa ZK

Opciones	Ref.	ANTR	BL	CB	CS	NE	NM	NM.OP		
50X50  5	3327								1	16
248  40	4327								1	12

- ANTR Antracita
- BL Blanco
- CB Cromo Brillo
- CI Cuero Inglés
- CO.ST Cobre Satin.
- CU Cuero
- CS Cromo Satin. EFCS
- Efect. Cromo Satin.
- EFLM Efect. Latón Mate
- INOX
- LM Latón Mate
- NM Níq. Mate
- NMM Níquel Mate Mate
- NMOP Níquel Mat. Opaco
- NE Negro
- PB Pulido Brillo
- PL Plata
- PL. AN Plata Anodizada









### 3337 Viper ZK

Opciones	Ref.	BL	CB	CI	CS	NE	NM		
50X50  5 	<b>3337</b>							1	16
248  40	<b>4337</b>							1	12









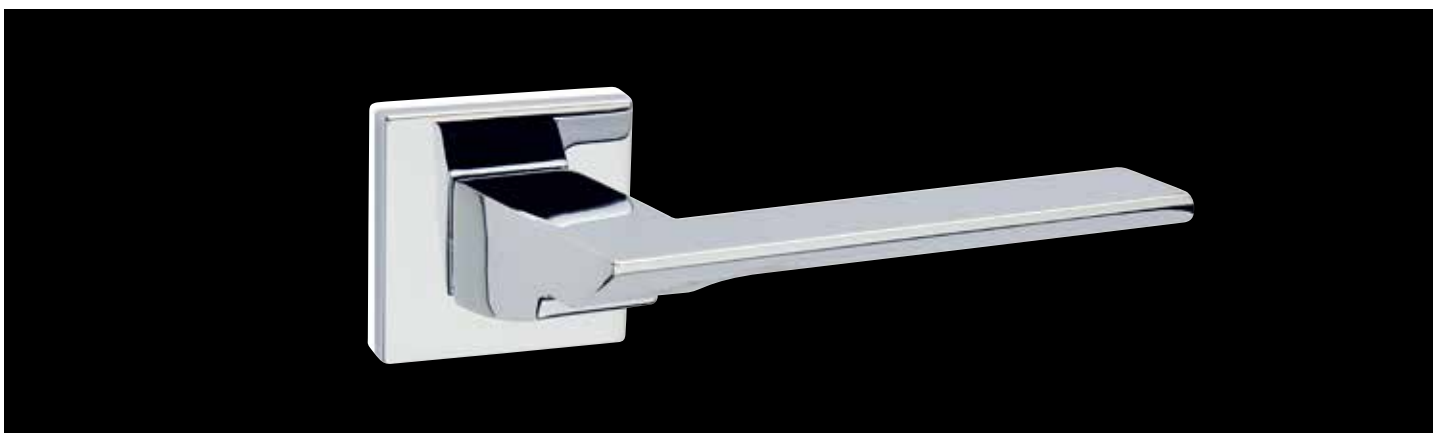

### 3357 Flake ZK

Opciones	Ref.	ANTR	CB	CI	NE	NM	NM.OP		
50X50  5 	<b>3357</b>							1	16
248  40 	<b>4357</b>							1	12









### 3367 Italia ZK

Opciones	Ref.	ANTR	BL	CB	CS	NE		
50X50  5 	<b>3367</b>						1	16
248  40 	<b>4367</b>						1	12







### 3377 Pura ZK

Opciones	Ref.	ANTR	BL	CB	CS	NE	NM.OP		
50X50  5 	<b>3377</b>							1	16
248  40 	<b>4377</b>							1	12

-  ANTR Antracita
-  BL Blanco
-  CB Cromo Brillo
-  CI Cuero Inglés
-  CO.ST Cobre Satin.
-  CU Cuero
-  CS Cromo Satin. EFCS
-  Efect. Cromo Satin.
-  EFLM Efect. Latón Mate
-  INOX
-  LM Latón Mate
-  NM Níq. Mate
-  NMM Níquel Mate Mate
-  NMOP Níquel Mat. Opaco
-  NE Negro
-  PB Pulido Brillo
-  PL Plata
-  PL.AN Plata Anodizada



### 3378 Swarovski LAT

Opciones	Ref.	CB		
50X50  5 	<b>3378</b>		1	16
248  40	<b>4378</b>		1	12

Con cristal de Swarovski





## 3388 Ice ZK

Opciones	Ref.	ANTR	BL	CB	CI	CS	NE	NM	NM.OP		
50x50  5	<b>3388</b>									1	16
248  40	<b>4388</b>									1	12



## 3398 Slim ZK

Opciones	Ref.	ANTR	BL	CB	CS	NE	NM	NMOP		
50x50  5	<b>3398</b>								1	16
248  40	<b>4398</b>								1	12









## 3720 Shape AL

Opciones	Ref.	ANTR	BL	CO.ST	EFCs	EFLM	NE	NM.OP		
Ø25  2	<b>3720</b>								1	24
247  45	<b>2320</b>								1	12

- ANTR Antracita
- BL Blanco
- CB Cromo Brillo
- CI Cuero Inglés
- CO.ST Cobre Satin.
- CU Cuero
- CS Cromo Satin. EFCs
- Efect. Cromo Satin.
- EFLM Efect. Latón Mate
- INOX
- LM Latón Mate
- NM Níq. Mate
- NMM Níquel Mate Mate
- NMOP Níquel Mat. Opaco
- NE Negro
- PB Pulido Brillo
- PL Plata
- PL. AN Plata Anodizada







**3766 Olanda** INOX

Opciones	Ref.	BL	CB	INOX	NE		
Ø25  2 	<b>3766</b>					1	24
247  45 	<b>2366</b>					1	12







**3887 Infinity** ZK

Opciones	Ref.	CS	NE		
52X35  10 	<b>3887</b>			1	16



NEW

**3889 Futura** AL

Opciones	Ref.	NE	PL.AN		
52X35  10 	<b>3889</b>			1	16





**3976 Kubo** AL

Opciones	Ref.	ANTR	BL	EFCS	NE	NM.OP		
25X25	<b>3976</b>						1	24
248	<b>4376</b>						1	12



**6318 Juliette** LAT

Opciones	Ref.	CI	PB	PL		
Ø50	<b>6318</b>				1	16
247	<b>2318</b>				1	12









**6328 Vittoria** LAT

Opciones	Ref.	CI	NE	PL		
Ø50	<b>6328</b>				1	16
247	<b>2328</b>				1	12

- ANTR Antracita
- BL Blanco
- CB Cromo Brillo
- CI Cuero Inglés
- CO.ST Cobre Satin.
- CU Cuero
- CS Cromo Satin. EFCS
- Efect. Cromo Satin.
- EFLM Efect. Latón Mate
- INOX
- LM Latón Mate
- NM Níq. Mate
- NMM Níquel Mate Mate
- NMOP Níquel Mat. Opaco
- NE Negro
- PB Pulido Brillo
- PL Plata
- PL. AN Plata Anodizada









**6338 Rodi** LAT

Opciones	Ref.	CB	PB		
Ø50  10 	<b>6338</b>			1	16
247  45 	<b>2338</b>			1	12



**6347 Calliope** ZK

Opciones	Ref.	CB	CI	CS	NM	PB	PL		
Ø50  10 	<b>6347</b>							1	16
247  45 	<b>2347</b>							1	12

Estas referencias se pueden montar con todas las manivelas y en todos los acabados de nuestra serie **Jandel Premium**

## PLACAS

### 23 LAT

Placa manivela



### 43 LAT

Placa manivela



### 00 LAT

Placa manivela sin muelle



## ROSETAS

### CXC

60 x 30 x 10 mm  
Roseta rect.  
Con muelle



### CX

60 x 30 x 10 mm  
Roseta oval  
Con muelle



## GRISÁN

### GC

64 x 30 x 10 mm  
Placa grisán  
DK rectangular



### G

64 x 30 x 10 mm  
Placa grisán  
DK oval



Ref.	ANTR	BL	CB	CI	CO.ST	CS	EFCS	EFLM	INOX	LM	NE	NM	NM.OP	PB	PL
23															
43					-			-	-	-				-	-
00															
GC					-			-	-	-				-	-
G															
CXC					-			-	-	-				-	-
CX															

- ANTR Antracita
- CI Cuero Inglés
- CS Cromo Satin. EFCS
- INOX
- NMM Níquel Mate Mate
- PB Pulido Brillo
- BL Blanco
- CO.ST Cobre Satin.
- Efect. Cromo Satin.
- LM Latón Mate
- NMOP Níquel Mat. Opaco
- PL Plata
- CB Cromo Brillo
- CU Cuero
- EFLM Efect. Latón Mate
- NM Níq. Mate
- NE Negro
- PL. AN Plata Anodizada



Ref.	BL	CB	INOX	NE	
<b>CG66</b> INOX					



Ref.	ANTR	BL	CO.ST	EFC5	EFLM	NE	NM.OP	
<b>CG20</b> AL								





Ref.	ANTR	BL	CB	CI	CS	NE	NM	NM.OP	
<b>G88C</b> ZK									



Ref.	mm (entre cent.)	BL	CB	INOX	NE	
EQ-M802 INOX	Ø25 (200)					2



Ref.	mm (entre cent.)	BL	CB	CO.ST	CS	EFLM	NE	NMM	
C349 ZK	200								2

Ref.	mm (entre cent.)	ANTR	BL	CB	CI	CO.ST	CS	EFLM	LM	NE	NM	NMM	PB	
C327 ZK	210													2

- ANTR Antracita
- CI Cuero Inglés
- CS Cromo Satin. EFCS
- INOX
- NMM Níquel Mate Mate
- PB Pulido Brillo
- BL Blanco
- CO.ST Cobre Satin.
- Efect. Cromo Satin.
- LM Latón Mate
- NMOP Níquel Mat. Opaco
- PL Plata
- CB Cromo Brillo
- CU Cuero
- EFLM Efect. Latón Mate
- NM Níq. Mate
- NE Negro
- PL. AN Plata Anodizada



NEW

Ref.	mm (entre cent.)	BL	CB	CI	CS	LM	NE	NM	PB	
C379 LAT	Ø20 (250)									2



NEW

Ref.	mm (entre cent.)	CB	CI	LM	NE	NM	PB	
C369 LAT	Ø22 (300)							



NEW

Ref.	mm (entre cent.)	CB	PL	
<b>C348 ZK</b>	<b>210</b>			



NEW

Ref.	mm (entre cent.)	CB	PB	
<b>C338 LAT</b>	<b>265</b>			

- ANTR Antracita
- CI Cuero Inglés
- CS Cromo Satin. EFCS
- INOX
- NMM Níquel Mate Mate
- PB Pulido Brillo
- BL Blanco
- CO.ST Cobre Satin.
- Efect. Cromo Satin.
- LM Latón Mate
- NMOP Níquel Mat. Opaco
- PL Plata
- CB Cromo Brillo
- CU Cuero
- EFLM Efect. Latón Mate
- NM Níq. Mate
- NE Negro
- PL. AN Plata Anodizada

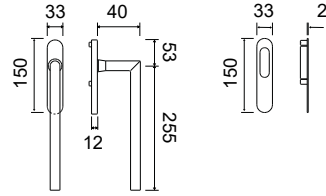

NEW

Ref.	ANTR	BL	INOX	NE	
102AL2 INOX					2

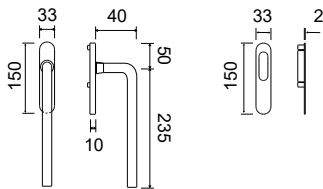

NEW

Ref.	CS	NE	PB	
359AL2 LAT				2



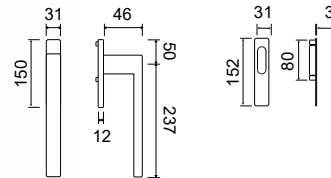



NEW

Ref.	ANTR	BL	CS	NE	
168AL2 ZK					2



-  ANTR Antracita
-  CI Cuero Inglés
-  CS Cromo Satin. EFCS
-  INOX
-  NMM Níquel Mate Mate
-  PB Pulido Brillo
-  BL Blanco
-  CO.ST Cobre Satin.
-  Efect. Cromo Satin.
-  LM Latón Mate
-  NMOP Níquel Mat. Opaco
-  PL Plata
-  CB Cromo Brillo
-  CU Cuero
-  EFLM Efect. Latón Mate
-  NM Níq. Mate
-  NE Negro
-  PL. AN Plata Anodizada

**Serie 13 roseta Ø50x5 mm**



**Bocallaves ZK**

Ref.	ANTR	BL	CB	CI	CO.ST	CS	EFCS	EFLM	INOX	LM	NE	NM	NM.OP	PB	PL	
13BY																10
13BO																10



**Condensas ZK**

Ref.	ANTR	BL	CB	CI	CO.ST	CS	EFCS	EFLM	INOX	LM	NE	NM	NM.OP	PB	PL	
13WC																5



NEW

**Condensas LAT**

Ref.	CB	CI	LM	NE	NM	PB	
MARIONWC							5

**Serie 33 roseta 50x50x5 mm**

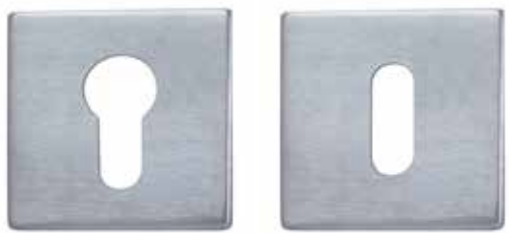

**Bocallaves ZK**

Ref.	ANTR	BL	CB	CI	CS	NE	NM	NM.OP	
<b>33BY</b>									10
<b>33BO</b>									10



**Condenas ZK**

Ref.	ANTR	BL	CB	CI	CS	NE	NM	NM.OP	
<b>33WC</b>									5

**Serie 37 roseta Ø25x2 mm**



**Bocallaves ZK**

Ref.	mm	ANTR	BL	CB	CO.ST	EFCS	EFLM	NE	NM.OP	
<b>37BY</b>	40x25x2									10
<b>37BO</b>	25x2									10



**Condenas LAT**

Ref.	ANTR	BL	CB	CO.ST	EFCS	EFLM	INOX	NE	NM.OP	
<b>37WC</b>										5

- ANTR Antracita
- BL Blanco
- CB Cromo Brillo
- CI Cuero Inglés
- CO.ST Cobre Satin.
- CU Cuero
- CS Cromo Satin. EFCS
- Efect. Cromo Satin.
- EFLM Efect. Latón Mate
- INOX
- LM Latón Mate
- NM Níq. Mate
- NMM Níquel Mate Mate
- NMOP Níquel Mat. Opaco
- NE Negro
- PB Pulido Brillo
- PL Plata
- PL. AN Plata Anodizada

**Serie 38 roseta 52x40x10 mm**



**Bocallaves ZK**

Ref.	CS	NE	
<b>38BY</b>			10
<b>38BO</b>			10



**Condenas LAT**

Ref.	CS	NE	
<b>38WC</b>			5

**Serie 39 roseta 25x25x2 mm**



**Bocallaves ZK**

Ref.	mm	ANTR	BL	EFCS	NE	NM.OP	
<b>39BY</b>	40x25x2						10
<b>39BO</b>	25x25x2						10



**Condenas LAT**

Ref.	ANTR	BL	EFCS	NE	NM.OP	
<b>39WC</b>						5

**Serie 63 roseta Ø50x10 mm**



**Bocallaves** LAT

Ref.	CB	CI	CS	NE	NM	PB	PL	
63BY								10
63BO								10



**Condenas** LAT

Ref.	CB	CI	CS	NE	NM	PB	PL	
63WC								5

**Roseta 35 mm**



**Condenas roseta Ø35x7 mm** LAT

Ref.	ANTR	BL	CB	CI	CO.ST	CS	EFCs	EFLM	LM	NE	NM	NM.OP	PB	PL	
01WC															5



**Condenas roseta 35x35x7 mm** LAT

Ref.	ANTR	BL	CB	CI	CS	NE	NM	NM.OP	
03WC									5

- ANTR Antracita
- BL Blanco
- CB Cromo Brillo
- CI Cuero Inglés
- CO.ST Cobre Satin.
- CU Cuero
- CS Cromo Satin. EFCs
- Efect. Cromo Satin.
- EFLM Efect. Latón Mate
- INOX
- LM Latón Mate
- NM Níq. Mate
- NMM Níquel Mate Mate
- NMOP Níquel Mat. Opaco
- NE Negro
- PB Pulido Brillo
- PL Plata
- PL. AN Plata Anodizada

**Roseta oval 60x30x10 mm**

NEW



**CXBY** ZK

Ref.	ANTR	BL	CB	CI	CO.ST	CS	EFCS	EFLM	NE	NM	NM.OP	PB	PL	
CXBY														10

NEW



**CXBO** ZK

Ref.	ANTR	BL	CB	CI	CO.ST	CS	EFCS	EFLM	NE	NM	NM.OP	PB	PL	
CXBO														10

**Roseta rectangular 60x30x10 mm**

NEW



**CXBYC** ZK

Ref.	ANTR	BL	CB	CI	CO.ST	CS	EFCS	EFLM	NE	NM	NM.OP	PB	PL	
CXBYC														10

NEW



**CXBOC** ZK

Ref.	ANTR	BL	CB	CI	CO.ST	CS	EFCS	EFLM	NE	NM	NM.OP	PB	PL	
CXBOC														10

## Bocallaves de seguridad (puerta de entrada)



**C630** roseta Ø50x10 mm (seguridad) LAT

Ref.	ANTR	BL	CB	CI	CS	LM	NE	NM	NMM	PB	PL	
<b>C630</b>												10



**C635** roseta 50x50x10 mm (seguridad) LAT

Ref.	ANTR	BL	CB	CI	CS	LM	NE	NM	NMM	PB	
<b>C635</b>											10



**Kit redondo Ø56 mm (Ø48 interior) LAT**

Ref.	ANTR	BL	CB	CI	CO.ST	CS	EFLM	LM	NE	NM	NM.OP	PB	PL	
<b>7610</b>														1



**Kit cuadrado 56x56 mm (Ø48 interior) LAT**

Ref.	ANTR	BL	CB	CI	CS	LM	NE	NM	NM.OP	PB	
<b>7630</b>											1

- ANTR Antracita
- BL Blanco
- CB Cromo Brillo
- CI Cuero Inglés
- CO.ST Cobre Satin.
- CU Cuero
- CS Cromo Satin. EFCS
- Efect. Cromo Satin.
- EFLM Efect. Latón Mate
- INOX
- LM Latón Mate
- NM Níq. Mate
- NMM Níquel Mate Mate
- NMOP Níquel Mat. Opaco
- NE Negro
- PB Pulido Brillo
- PL Plata
- PL. AN Plata Anodizada

Ref. 75220 LAT

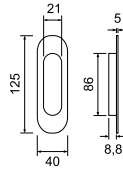

Ref. 75200 LAT

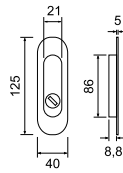



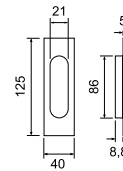

Ref. 75420 LAT

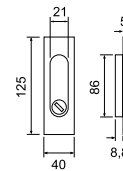

Ref. 75400 LAT



Opciones	Ref.	ANTR	BL	CB	CI	CS	CU	LM	NE	NM	NM.OP	PB	
125-40 	<b>7.5220</b>												
125-40 	<b>7.5200</b>												
125-40 	<b>7.5420</b>												
125-40 	<b>7.5400</b>												



Kits correderas



Kit redondo c/condena Ø56 mm (Ø48 interior) ZK

Ref.	BL	CB	CS	CU	LM	NE	NM	PB	
9510									1



Kit cuadrado c/condena 56x56 mm (Ø48 interior) ZK

Ref.	BL	CB	CS	LM	NE	NM	PB	
9530								1

- ANTR Antracita
- CI Cuero Inglés
- CS Cromo Satin. EFCS
- INOX
- NMM Níquel Mate Mate
- PB Pulido Brillo
- BL Blanco
- CO.ST Cobre Satin.
- Efect. Cromo Satin.
- LM Latón Mate
- NMOP Níquel Mat. Opaco
- PL Plata
- CB Cromo Brillo
- CU Cuero
- EFLM Efect. Latón Mate
- NM Níq. Mate
- NE Negro
- PL. AN Plata Anodizada



**1023 Gótica** LAT

Opciones	Ref.	CI	PL		
Ø50  10	<b>1023</b>			1	20
280  50	<b>8023</b>			1	20



**1045 Flexa** LAT

Opciones	Ref.	CI	CS	LM	NM	PB		
Ø50  10	<b>1045</b>						1	25
241  42	<b>1545</b>						1	20

JANDEL ORIGINAL



**1059 Air** ZK

Opciones	Ref.	AN	CI	NE	PL		
Ø50  10	<b>1059</b>					1	20
265  48	<b>4459</b>					1	20



**1072 Nuri** LAT

Opciones	Ref.	CI	CS	LM	NM	PB		
Ø50  10	<b>1072</b>						1	25
241  42	<b>1572</b>						1	20



**1075 Corinne** LAT

Opciones	Ref.	CI	CU	LM	MR	NM	PB	PL		
Ø50  10	<b>1075</b>								1	25
241  42	<b>1575</b>								1	20



**1080 Pilar** LAT

Opciones	Ref.	CC	CI	CS	LM	NM	PB		
Ø50  10	<b>1080</b>							1	20
241  42	<b>1580</b>							1	20



**1082 Kubic** LAT

Opciones	Ref.	CC	CS	LM	NM	PB		
Ø50 10	<b>1082</b>						1	20
241 42	<b>1582</b>						1	20



**1105 Gaudel** LAT

Opciones	Ref.	CI	CS	LM	NM	PB		
Ø50 10	<b>1105</b>						1	25
241 42	<b>1605</b>						1	20



**1090 Marina** LAT

Opciones	Ref.	CS	LM	NM		
Ø50 10	<b>1090</b>				1	25
241 42	<b>1590</b>				1	20



**1092 Teka** ZK

Opciones	Ref.	CS	NM		
Ø50 10	<b>1092</b>			1	25
241 42	<b>1592</b>			1	20



- AN Anticato
- CB Cromo Brillo
- CS Cromo Satinado
- MR Marrón
- NMM Níquel Mate Mate
- PB Pulido Brillo
- PVLM PVD Lat. Mate
- ANTR Antracita
- CC Cromo Combinado
- CU Cuero
- NE Negro
- NM.OP Níq. Mat. Opaco
- PS Pulido Satin.
- BL Blanco
- CI Cuero Inglés
- LM Latón Mate
- NM Níquel Mate
- NS Níquel Satinado
- PL Plata

JANDEL ORIGINAL



**1115 Venere** LAT

Opciones	Ref.	CB	CI	CS	LM	NM		
Ø50 10	<b>1115</b>						1	20
241 42	<b>1615</b>						1	20



**1209 Eva** ZK

Opciones	Ref.	ANTR	CB	CS	NE	PVLM		
Ø50 10	<b>1209</b>						1	20
241 42	<b>1509</b>						1	20

JANDEL ORIGINAL



**1213 Elle** ZK

Opc.	Ref.	ANTR	BL	CB	CI	CS	LM	NE	NM	PVLM		
Ø50 10	<b>1213</b>										1	20
241 42	<b>1513</b>										1	20



**1219 Laia** ZK

Opciones	Ref.	CB	CS	NE	NM		
Ø50 10	<b>1219</b>					1	20
241 42	<b>1519</b>					1	20





## 1224 Juan ZK

Opciones	Ref.	CB	CS	NM		
Ø50	1224				1	20
241	1524				1	20



## 1229 Dolce ZK

Opciones	Ref.	CB	CS	NE	NMM		
Ø50	1229					1	20
241	1529					1	20



## 1234 Virgo ZK

Opciones	Ref.	CB	CS	NE	NM		
Ø50	1234					1	20
241	1534					1	20



## 1239 Susi ZK

Opciones	Ref.	CB	CS	NE	NMM		
Ø50	1239					1	20
241	1539					1	20



## 1249 Clubb ZK

Opciones	Ref.	ANTR	BL	CB	CI	CS	NE	NMM		
50	1249								1	20
241	1549								1	20



## 1254 Aria ZK

Opciones	Ref.	CB	CS	NM		
Ø50	1254				1	20
241	1554				1	20







- AN Anticato
- CB Cromo Brillo
- CS Cromo Satinado
- MR Marrón
- NMM Níquel Mate Mate
- PB Pulido Brillo
- PVLM PVD Lat. Mate
- ANTR Antracita
- CC Cromo Combinado
- CU Cuero
- NE Negro
- NM.OP Niq. Mat. Opaco
- PS Pulido Satin.
- BL Blanco
- CI Cuero Inglés
- LM Latón Mate
- NM Níquel Mate
- NS Níquel Satinado
- PL Plata

JANDEL ORIGINAL



NEW

12TE ZK

Opciones	Ref.	BL	CI	LM	NE	NM		
	12TE						1	20
	15TE						1	20
	WCTE						2	40
	HQTE						10	200
	H2TE						5	100









JANDEL ORIGINAL





- |                  |                      |                     |                  |                         |                    |                       |
|------------------|----------------------|---------------------|------------------|-------------------------|--------------------|-----------------------|
| ● AN Anticato    | ● CB Cromo Brillo    | ● CS Cromo Satinado | ● MR Marrón      | ● NMM Níquel Mate Mate  | ● PB Pulido Brillo | ● PVL M PVD Lat. Mate |
| ● ANTR Antracita | ● CC Cromo Combinado | ● CU Cuero          | ● NE Negro       | ● NM.OP Níq. Mat. Opaco | ● PS Pulido Satin. |                       |
| ○ BL Blanco      | ● CI Cuero Inglés    | ● LM Latón Mate     | ● NM Níquel Mate | ● NS Níquel Satinado    | ● PL Plata         |                       |



### 1264 Heavy ZK

Opciones	Ref.	CB	CS	NM		
Ø50  10 	<b>1264</b>				1	20
241 	<b>1564</b>				1	20





### 2040 Línea LAT

Opciones	Ref.	CS	LM	NM		
Ø50  10 	<b>2040</b>				1	25
241 	<b>2540</b>				1	20





JANDEL ORIGINAL



### 6042 Polaris LAT

Opciones	Ref.	CC	CI	CS	CU	LM	NM	PB	PS		
Ø50  10 	<b>6042</b>									1	25
241 	<b>1542</b>									1	20

### Karol ZK

Opciones	Ref.	CI	LM	NM	PB		
Ø50  10 	<b>KAROL ROSETA</b>					1	25
241 	<b>KAROL PLACA</b>					1	20







**EQ-R207** ZK

Opciones	PB		
Ø50 10		1	20



**EQ-R208** ZK

Opciones	CU		
Ø50 10		1	20



**EQ-R209** ZK

Opciones	NM		
Ø50 10		1	20



**EQ-R450** LAT

Opciones	CU	PB		
Ø50 10			1	20

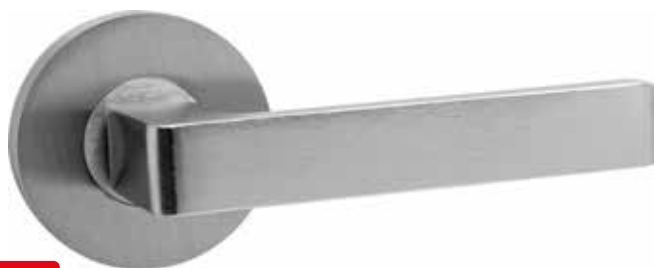

**NEW**

Tapa Pomos

**EQ-R653** ZK

mm	CS	NE	NM		
Ø 65				1	20



**NEW**

Tapa Pomos

**EQ-R657** ZK





mm	CU	NE	NM	PB		
Ø 65					1	20

- AN Anticato
- CB Cromo Brillo
- CS Cromo Satinado
- MR Marrón
- NMM Níquel Mate Mate
- PB Pulido Brillo
- PVL PVD Lat. Mate
- ANTR Antracita
- CC Cromo Combinado
- CU Cuero
- NE Negro
- NM.OP Níq. Mat. Opaco
- PS Pulido Satin.
- BL Blanco
- CI Cuero Inglés
- LM Latón Mate
- NM Níquel Mate
- NS Níquel Satinado
- PL Plata

JANDEL ORIGINAL







**EQ-R890** LAT

Opciones	AN	CI	CU	NM	PB	PL		
Ø50  10 							1	20

\*Porcelana craquelé







**EQ-R891** LAT

Opciones	AN	CI	CU	NM	PB	PL		
Ø50  10 							1	20

\*Porcelana beige



**EQ-R892** LAT

Opciones	AN	CI	CU	NM	PB	PL		
Ø50  10 							1	20

\*Porcelana blanca









JANDEL ORIGINAL

- |                  |                      |                     |                  |                         |                    |                       |
|------------------|----------------------|---------------------|------------------|-------------------------|--------------------|-----------------------|
| ● AN Anticato    | ● CB Cromo Brillo    | ● CS Cromo Satinado | ● MR Marrón      | ● NMM Níquel Mate Mate  | ● PB Pulido Brillo | ● PVL M PVD Lat. Mate |
| ● ANTR Antracita | ● CC Cromo Combinado | ● CU Cuero          | ● NE Negro       | ● NM.OP Níq. Mat. Opaco | ● PS Pulido Satin. |                       |
| ○ BL Blanco      | ● CI Cuero Inglés    | ● LM Latón Mate     | ● NM Níquel Mate | ● NS Níquel Satinado    | ● PL Plata         |                       |







### Uovo LAT





Opciones	Ref.	CB	CI	CS	CU	LM	NM	PB		
Ø50  10 	UOVO ROSETA								1	25
241 	UOVO PLACA								1	20



### Polo (PORCELANA) LAT

Opciones	Ref.	CI	NM	PB		
Ø50  10 	POLO PORC. ROSETA				1	25
241 	POLO PORC. PLACA				1	20





### Polo LAT

Opciones	Ref.	CB	CI	CS	CU	LM	NM	PB		
Ø50  10 	POLO ROSETA								1	25
241 	POLO PLACA								1	20









**SV-R650** ZK

Opciones	CB	CS	NM		
Ø50  10 				1	20







**SV-C650** ZK

Opciones	CB	CS	NM		
50x50  10 				1	20







**SV-R950** ZK

Opciones	NM		
Ø50  10 		1	20



**SV-C950** ZK

Opciones	NM		
50x50  10 		1	20



JANDEL ORIGINAL

- AN Anticato
- CB Cromo Brillo
- CS Cromo Satinado
- MR Marrón
- NMM Níquel Mate Mate
- PB Pulido Brillo
- PVLML PVD Lat. Mate
- ANTR Antracita
- CC Cromo Combinado
- CU Cuero
- NE Negro
- NM.OP Níq. Mat. Opaco
- PS Pulido Satin.
- BL Blanco
- CI Cuero Inglés
- LM Latón Mate
- NM Níquel Mate
- NS Níquel Satinado
- PL Plata

## Manivelas



### 3012 Laura LAT

Opciones	Ref.	CB	CC	CS	NM		
50X50 10	<b>3012</b>					1	20
269 55	<b>3512</b>					1	20
241 42	<b>4512</b>					1	20

### 3022 Natalia LAT

Opciones	Ref.	CB	CC	CS	NM		
50X50 10	<b>3022</b>					1	20
269 55	<b>3522</b>					1	20
241 42	<b>4522</b>					1	20



### 3070 Iber LAT

Opciones	Ref.	CC	CI	CS	NM		
50X50 10	<b>3070</b>					1	20
269 55	<b>3570</b>					1	20
241 42	<b>4570</b>					1	20

### 3080 Pilar LAT

Opciones	Ref.	CC	CI	CS	LM	NM	PB		
50X50 10	<b>3080</b>							1	20
269 55	<b>3580</b>							1	20
241 42	<b>4580</b>							1	20



### 3082 Kubic LAT

Opc.	Ref.	CB	CC	CS	LM	NM	PB		
50X50 10	<b>3082</b>							1	20
269 55	<b>3582</b>							1	20
241 42	<b>4582</b>							1	20

### 3413 Elle ZK

Opc.	Ref.	ANTR	BL	CB	CI	CS	LM	NE	NM	PVLM		
50X50 10	<b>3413</b>										1	20
269 55	<b>3513</b>	-	-							-	1	20
241 42	<b>4513</b>										1	20





## 3424 Juan ZK

Opciones	Ref.	CB	CS	NM		
50X50	<b>3424</b>				1	20
269	<b>3524</b>				1	20
241	<b>4524</b>				1	20



## 3429 Dolce ZK

Opciones	Ref.	CB	CS	NE	NMM		
50X50	<b>3429</b>					1	20
269	<b>3529</b>				-	1	20
241	<b>4529</b>					1	20



## 3434 Virgo ZK

Opciones	Ref.	CB	CS	NE	NM		
50X50	<b>3434</b>					1	20
269	<b>3534</b>					1	20
241	<b>4534</b>					1	20



## 3449 Clubb ZK

Opciones	Ref.	BL	CB	CS	NE	NMM		
50X50	<b>3449</b>						1	20
269	<b>3549</b>	-				-	1	20
241	<b>4549</b>						1	20



- AN Anticato
- ANTR Antracita
- BL Blanco
- CB Cromo Brillo
- CC Cromo Combinado
- CI Cuero Inglés
- CS Cromo Satinado
- CU Cuero
- LM Latón Mate
- MR Marrón
- NE Negro
- NM Níquel Mate
- NMM Níquel Mate Mate
- NM.OP Níq. Mat. Opaco
- NS Níquel Satinado
- PB Pulido Brillo
- PS Pulido Satin.
- PL Plata
- PVLML PVD Lat. Mate



JANDEL ORIGINAL









**3570** LAT

CC	CI	CS	NM		
				1	20



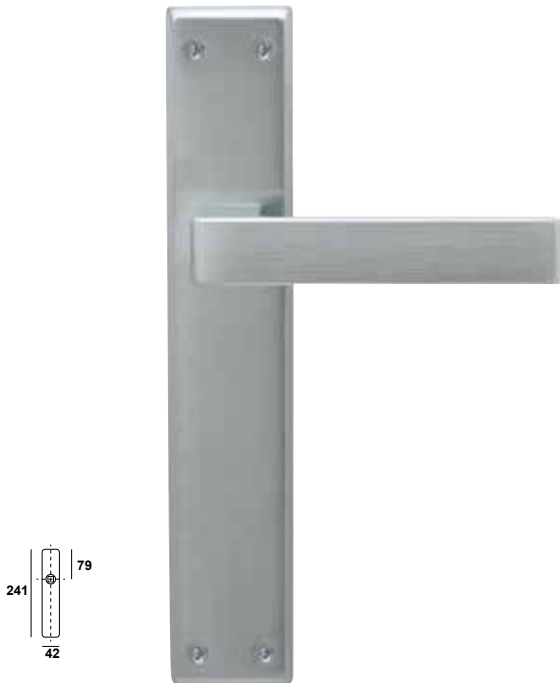

**SV-PC65** ZK

CB	CS	NM		
			1	20





**4513** LAT-ZK

ANTR	BL	CB	CC	CI	CS	LM	NE	NM	PVLM		
										1	20





**SV-P650** ZK

CB	CS	NM		
			1	20

- AN Anticato
- CB Cromo Brillo
- CS Cromo Satinado
- MR Marrón
- NMM Níquel Mate Mate
- PB Pulido Brillo
- PVLM PVD Lat. Mate
- ANTR Antracita
- CC Cromo Combinado
- CU Cuero
- NE Negro
- NM.OP Níq. Mat. Opaco
- PS Pulido Satin.
- BL Blanco
- CI Cuero Inglés
- LM Latón Mate
- NM Níquel Mate
- NS Níquel Satinado
- PL Plata





**3223** LAT

CI	PB		
		1	20



NEW

**EQ-9690** LAT

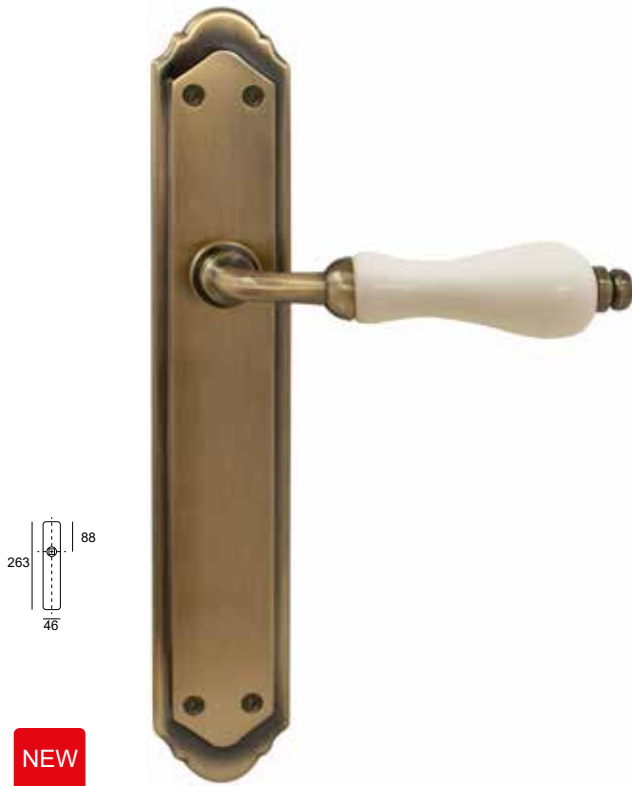

CI		
	1	20

\*Porcelana craquelé



NEW

**EQ-9691** LAT

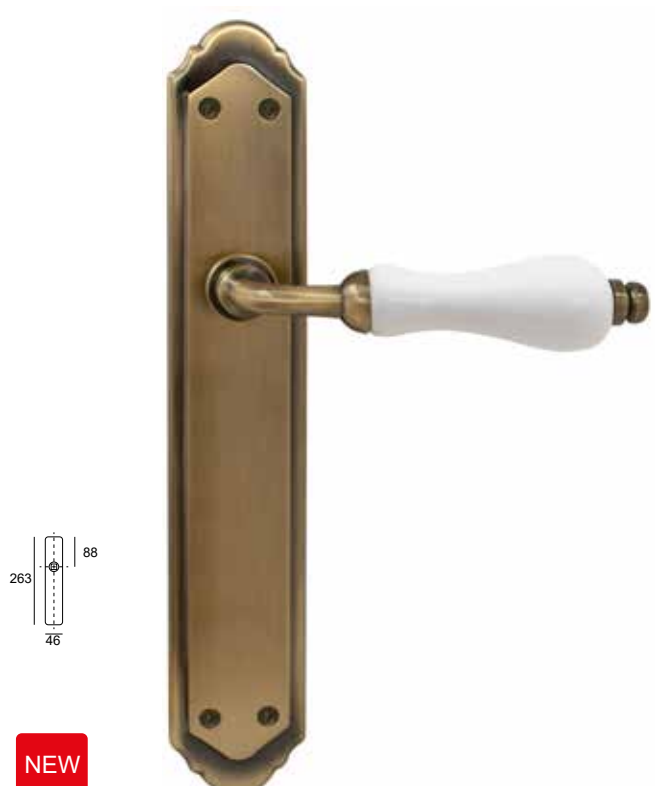

CI		
	1	20

\*Porcelana beige



NEW

**EQ-9692** LAT

CI		
	1	20

\*Porcelana blanca

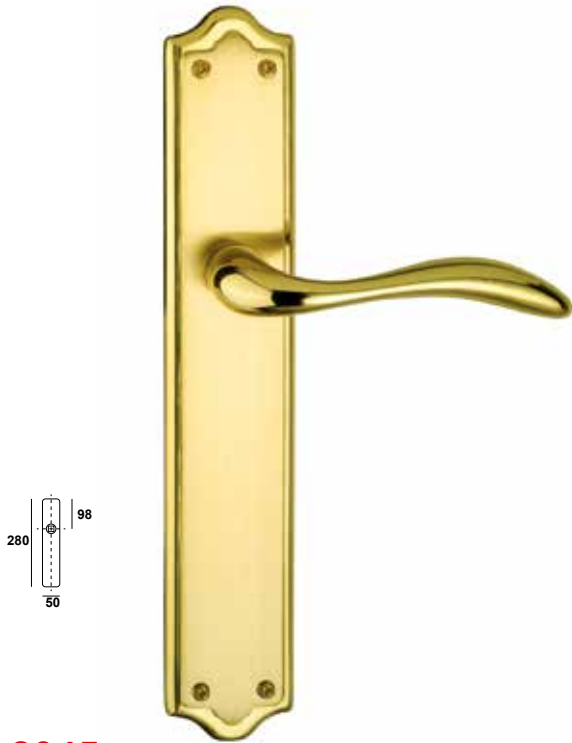

**8045** LAT

CI	NM	PS		
			1	20



**1605** LAT

CI	CS	LM	NM	PB		
					1	20



**4459** LAT-ZK

AN	CI	NE	PL		
				1	20



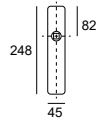

- AN Anticato
- ANTR Antracita
- BL Blanco
- CB Cromo Brillo
- CC Cromo Combinado
- CI Cuero Inglés
- CS Cromo Satinado
- CU Cuero
- LM Latón Mate
- MR Marrón
- NE Negro
- NM Níquel Mate
- NMM Níquel Mate Mate
- NM.OP Níq. Mat. Opaco
- NS Níquel Satinado
- PB Pulido Brillo
- PS Pulido Satin.
- PL Plata
- PVL M PVD Lat. Mate

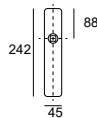

Ref.	Opciones	mm	PB		
<b>EQ-100B</b>	Jgo. Manivela	248x45		1	20
<b>EQ-M100</b>	Manillón	248x45		2	40
<b>EQ-L100</b>	Placa limpieza	248x45		10	100
<b>EQ-C100</b>	Asa corta c/placa	248x45		2	40
<b>EQ-T203</b>	Tirador armario	123x35		20	200
<b>EQ-A203</b>	Tirador maletero	83x35		20	200
<b>EQ-P100</b>	Placa pomo fijo	248x45		2	40
<b>EQ-P100MV</b>	Placa pomo móvil	248x45		2	40

LAT



Ref.	Opciones	mm	CU	PS		
<b>EQ-297</b>	Jgo. Manivela	242x45			1	20
<b>EQ-M297</b>	Manillón	242x45			2	40
<b>EQ-L297</b>	Placa limpieza	242x45			10	100
<b>EQ-C297</b>	Asa corta c/placa	242x45			2	40
<b>EQ-T400</b>	Tirador armario	123x35			20	200
<b>EQ-A400</b>	Tirador maletero	83x35			20	200
<b>EQ-P297</b>	Placa pomo fijo	242x45			2	40
<b>EQ-P297MV</b>	Placa pomo móvil	242x45			2	40

LAT

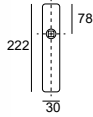

Ref.	Opciones	mm	CU	NM	PB		
<b>EQ-330</b>	Jgo. Manivela	222x30				1	20

LAT

JANDEL ORIGINAL

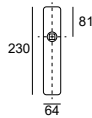



Ref.	Opciones	mm	CU	PS		
<b>EQ-525</b>	Jgo. Manivela	230x64			1	20
<b>EQ-M525</b>	Manillón	230x64			2	40
<b>EQ-L525</b>	Placa limpieza	230x64			10	100
<b>EQ-C525</b>	Asa corta c/placa	230x64			2	40
<b>EQ-P525</b>	Placa pomo fijo	230x64			2	40
<b>EQ-P525MV</b>	Placa pomo móvil	230x60			2	40

LAT

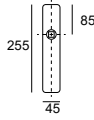

- AN Anticato
- CB Cromo Brillo
- CS Cromo Satinado
- MR Marrón
- NMM Níquel Mate Mate
- PB Pulido Brillo
- PVL M PVD Lat. Mate
- ANTR Antracita
- CC Cromo Combinado
- CU Cuero
- NE Negro
- NM.OP Níq. Mat. Opaco
- PS Pulido Satin.
- BL Blanco
- CI Cuero Inglés
- LM Latón Mate
- NM Níquel Mate
- NS Níquel Satinado
- PL Plata

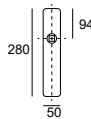

Ref.	Opciones	mm	CU	PS		
<b>EQ-796</b>	Jgo. Manivela	255x45			1	20
<b>EQ-M796</b>	Manillón	255x45			2	40
<b>EQ-L796</b>	Placa limpieza	255x45			10	100
<b>EQ-C796</b>	Asa corta c/placa	255x45			2	40
<b>EQ-T599</b>	Tirador armario	129x33			20	200
<b>EQ-A599</b>	Tirador maletero	89x33			20	200
<b>EQ-P796</b>	Placa pomo fijo	255x45			2	40
<b>EQ-P796MV</b>	Placa pomo móvil	255x45			2	40

LAT



Ref.	Opciones	mm	CU	PS		
<b>EQ-1599</b>	Jgo. Manivela	280x50			1	20
<b>EQ-M599</b>	Manillón	280x50			2	40
<b>EQ-L599</b>	Placa limpieza	280x50			10	100
<b>EQ-C599</b>	Asa corta c/placa	280x50			2	40
<b>EQ-T599</b>	Tirador armario	128x33			20	200
<b>EQ-A599</b>	Tirador maletero	88x33			20	200
<b>EQ-P599</b>	Placa pomo fijo	280x50			2	40
<b>EQ-P599MV</b>	Placa pomo móvil	280x50			2	40

LAT

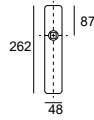

Ref.	Opciones	mm	CU	PS		
<b>EQ-2733</b>	Jgo. Manivela	262x48			1	20
<b>EQ-M733</b>	Manillón	262x48			2	40
<b>EQ-L733</b>	Placa limpieza	262x48			10	100
<b>EQ-C733</b>	Asa corta c/placa	262x48			2	40
<b>EQ-T400</b>	Tirador armario	128x33			20	200
<b>EQ-A400</b>	Tirador maletero	88x33			20	200
<b>EQ-P733</b>	Placa pomo fijo	262x48			2	40
<b>EQ-P733MV</b>	Placa pomo móvil	262x48			2	40

LAT

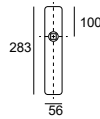



Ref.	Opciones	mm	NM	PS		
<b>EQ-3800</b>	Jgo. Manivela	283X56			1	20
<b>EQ-M380</b>	Manillón	283X56			2	40
<b>EQ-L800</b>	Placa limpieza	283X56			10	100
<b>EQ-C800</b>	Asa corta c/placa	283X56			2	40
<b>EQ-T400</b>	Tirador armario	128x33			20	200
<b>EQ-A400</b>	Tirador maletero	88x33			20	200
<b>EQ-P800</b>	Placa pomo fijo	283X56			2	40
<b>EQ-P800MV</b>	Placa pomo móvil	283x56			2	40

LAT

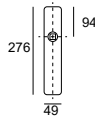

- AN Anticato
- ANTR Antracita
- BL Blanco
- CB Cromo Brillo
- CC Cromo Combinado
- CI Cuero Inglés
- CS Cromo Satinado
- CU Cuero
- LM Latón Mate
- MR Marrón
- NE Negro
- NM Níquel Mate
- NMM Níquel Mate Mate
- NM.OP Níq. Mat. Opaco
- NS Níquel Satinado
- PB Pulido Brillo
- PS Pulido Satin.
- PL Plata
- PVLML PVD Lat. Mate

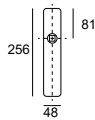

Ref.	Opciones	mm	CU	PS		
<b>EQ-4402</b>	Jgo. Manivela	276x49			1	20
<b>EQ-M402</b>	Manillón	276x49			2	40
<b>EQ-L402</b>	Placa limpieza	276x49			10	100
<b>EQ-C402</b>	Asa corta c/placa	276x49			2	40
<b>EQ-T599</b>	Tirador armario	128x33			20	200
<b>EQ-A599</b>	Tirador maletero	88x33			20	200
<b>EQ-P402</b>	Placa pomo fijo	276x49			2	40
<b>EQ-P402MV</b>	Placa pomo móvil	276x49			2	40

LAT





Ref.	Opciones	mm	CU	PS		
<b>EQ-4406</b>	Jgo. Manivela	256x48			1	20
<b>EQ-M406</b>	Manillón	256x48			2	40
<b>EQ-L406</b>	Placa limpieza	256x48			10	100
<b>EQ-C406</b>	Asa corta c/placa	256x48			2	40
<b>EQ-T400</b>	Tirador armario	128x33			20	200
<b>EQ-A400</b>	Tirador maletero	88x33			20	200
<b>EQ-P406</b>	Placa pomo fijo	256x48			2	40
<b>EQ-P406MV</b>	Placa pomo móvil	256x48			2	40

LAT

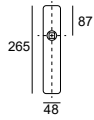



Ref.	Opciones	mm	CU	NM	PS		
<b>EQ-4419</b>	Jgo. Manivela	265x48				1	20
<b>EQ-M419</b>	Manillón	265x48				2	40
<b>EQ-L419</b>	Placa limpieza	265x48				10	100
<b>EQ-C419</b>	Asa corta c/placa	265x48				2	40
<b>EQ-T400</b>	Tirador armario	128x33				20	200
<b>EQ-A400</b>	Tirador maletero	88x33				20	200
<b>EQ-P419</b>	Placa pomo fijo	265x48				2	40
<b>EQ-P419MV</b>	Placa pomo móvil	265x48				2	40



LAT

JANDEL ORIGINAL



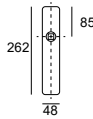

- AN Anticato
- CB Cromo Brillo
- CS Cromo Satinado
- MR Marrón
- NMM Níquel Mate Mate
- PB Pulido Brillo
- PVLML PVD Lat. Mate
- ANTR Antracita
- CC Cromo Combinado
- CU Cuero
- NE Negro
- NM.OP Níq. Mat. Opaco
- PS Pulido Satin.
- BL Blanco
- CI Cuero Inglés
- LM Latón Mate
- NM Níquel Mate
- NS Níquel Satinado
- PL Plata



Ref.	Opciones	mm	CU	PS		
<b>EQ-4423</b>	Jgo. Manivela	262x48			1	20
<b>EQ-M423</b>	Manillón	262x48			2	40
<b>EQ-L423</b>	Placa limpieza	262x48			10	100
<b>EQ-C423</b>	Asa corta c/placa	262x48			2	40
<b>EQ-T424</b>	Tirador armario	131x35			20	200
<b>EQ-A424</b>	Tirador maletero	85x35			20	200
<b>EQ-P423</b>	Placa pomo fijo	262x48			2	40
<b>EQ-P423MV</b>	Placa pomo móvil	262x48			2	40

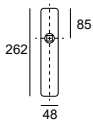

LAT



Ref.	Opciones	mm	CU	PS		
<b>EQ-4424</b>	Jgo. Manivela	262x48			1	20
<b>EQ-M424</b>	Manillón	262x48			2	40
<b>EQ-L424</b>	Placa limpieza	262x48			10	100
<b>EQ-C424</b>	Asa corta c/placa	262x48			2	40
<b>EQ-T424</b>	Tirador armario	131x35			20	200
<b>EQ-A424</b>	Tirador maletero	85x35			20	200
<b>EQ-P424</b>	Placa pomo fijo	262x48			2	40
<b>EQ-P424MV</b>	Placa pomo móvil	262x48			2	40

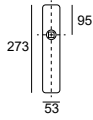

LAT

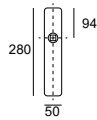

Ref.	Opciones	mm	CU	PS		
<b>EQ-4450</b>	Jgo. Manivela	273X53			1	20
<b>EQ-M450</b>	Manillón	273X53			2	40
<b>EQ-L450</b>	Placa limpieza	273X53			10	100
<b>EQ-C450</b>	Asa corta c/placa	273X53			2	40
<b>EQ-T400</b>	Tirador armario	128x33			20	200
<b>EQ-A400</b>	Tirador maletero	88x33			20	200
<b>EQ-P450</b>	Placa pomo fijo	273X53			2	40
<b>EQ-P450MV</b>	Placa pomo móvil	273x53			2	40

LAT





Ref.	Opciones	mm	CU	PS		
<b>EQ-8300</b>	Jgo. Manivela	280x50			1	20
<b>EQ-M300</b>	Manillón	280x50			2	40
<b>EQ-L300</b>	Placa limpieza	280x50			10	100
<b>EQ-C300</b>	Asa corta c/placa	280x50			2	40
<b>EQ-T400</b>	Tirador armario	128x33			20	200
<b>EQ-A400</b>	Tirador maletero	88x33			20	200
<b>EQ-P300</b>	Placa pomo fijo	280x50			2	40
<b>EQ-P300MV</b>	Placa pomo móvil	280x50			2	40

LAT

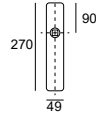
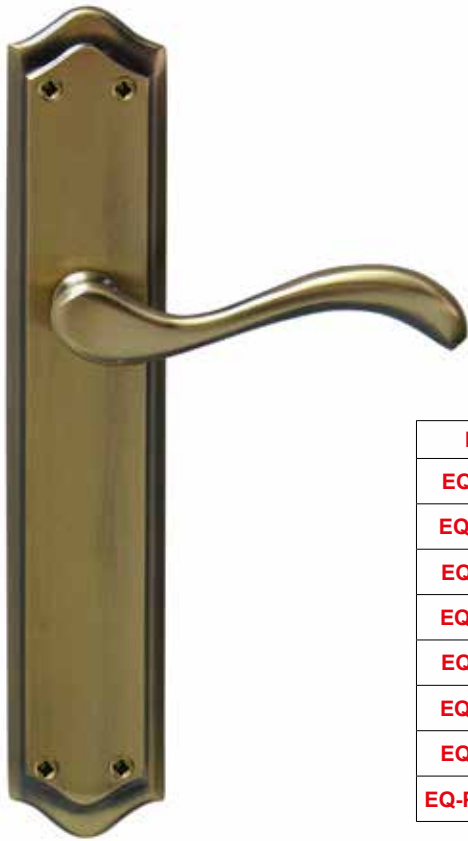

- AN Anticato
- CB Cromo Brillo
- CS Cromo Satinado
- MR Marrón
- NMM Níquel Mate Mate
- PB Pulido Brillo
- PVLM PVD Lat. Mate
- ANTR Antracita
- CC Cromo Combinado
- CU Cuero
- NE Negro
- NM.OP Níq. Mat. Opaco
- PS Pulido Satin.
- BL Blanco
- CI Cuero Inglés
- LM Latón Mate
- NM Níquel Mate
- NS Níquel Satinado
- PL Plata

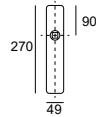

Ref.	Opciones	mm	CU	PS		
<b>EQ-9500</b>	Jgo. Manivela	270x49			1	20
<b>EQ-M500</b>	Manillón	270x49			2	40
<b>EQ-L500</b>	Placa limpieza	270x49			10	100
<b>EQ-C500</b>	Asa corta c/placa	270x49			2	40
<b>EQ-T400</b>	Tirador armario	128x33			20	200
<b>EQ-A400</b>	Tirador maletero	88x33			20	200
<b>EQ-P500</b>	Placa pomo fijo	270x49			2	40
<b>EQ-P500MV</b>	Placa pomo móvil	270x49			2	40

LAT



Ref.	Opciones	mm	CU	PS		
<b>EQ-9501</b>	Jgo. Manivela	270x49			1	20
<b>EQ-M500</b>	Manillón	270x49			2	40
<b>EQ-L500</b>	Placa limpieza	270x49			10	100
<b>EQ-C500</b>	Asa corta c/placa	270x49			2	40
<b>EQ-T400</b>	Tirador armario	128x33			20	200
<b>EQ-A400</b>	Tirador maletero	88x33			20	200
<b>EQ-P500</b>	Placa pomo fijo	270x49			2	40
<b>EQ-P500MV</b>	Placa pomo móvil	270x49			2	40

LAT















Ref.	Opciones	mm	CI	CU	PS		
<b>EQ-9600</b>	Jgo. Manivela	263x46				1	20
<b>EQ-M600</b>	Manillón	263x46				2	40
<b>EQ-L600</b>	Placa limpieza	263x46				10	100
<b>EQ-C600</b>	Asa corta c/placa	263x46				2	40
<b>EQ-T400</b>	Tirador armario	128x33				20	200
<b>EQ-A400</b>	Tirador maletero	88x33				20	200
<b>EQ-P600</b>	Placa pomo fijo	263x46				2	40
<b>EQ-P600MV</b>	Placa pomo móvil	263x46				2	40

LAT

JANDEL ORIGINAL



-  AN Anticato
-  CB Cromo Brillo
-  CS Cromo Satinado
-  MR Marrón
-  NMM Níquel Mate Mate
-  PB Pulido Brillo
-  PVLM PVD Lat. Mate
-  ANTR Antracita
-  CC Cromo Combinado
-  CU Cuero
-  NE Negro
-  NM.OP Níq. Mat. Opaco
-  PS Pulido Satin.
-  BL Blanco
-  CI Cuero Inglés
-  LM Latón Mate
-  NM Níquel Mate
-  NS Níquel Satinado
-  PL Plata

JANDEL ORIGINAL



Estas referencias se pueden montar con todas las manivelas y en todos los acabados de nuestra serie **Jandel Original**

## PLACAS LAT

**35** Placa manivela



**45** Placa manivela



**15** Placa manivela



**00** Placa manivela Sin muelle



## ROSETAS ZK

**CXC** 64 x 30 mm Roseta rect. Con muelle



**CX** 64 x 30 mm Roseta oval Con muelle



## GRISÁN ZK

**GC** 64 x 30 mm Placa grisán DK rectangular





**G** 64 x 30 mm Placa grisán DK oval



Ref.	AN	ANTR	BL	CB	CI	CS	CU	LM	MR	NE	NM	NMM	PB	PL	PVLM
<b>35</b>		-	-									-			-
<b>45</b>															
<b>15</b>															
<b>00</b>		-										-			-
<b>GC</b>		-										-			-
<b>G</b>		-										-			-
<b>CXC</b>		-										-			-
<b>GX</b>		-										-			-

- AN Anticato
- CB Cromo Brillo
- CS Cromo Satinado
- MR Marrón
- NMM Níquel Mate Mate
- PB Pulido Brillo
- PVLM PVD Lat. Mate
- ANTR Antracita
- CC Cromo Combinado
- CU Cuero
- NE Negro
- NM.OP Níq. Mat. Opaco
- PS Pulido Satin.
- BL Blanco
- CI Cuero Inglés
- LM Latón Mate
- NM Níquel Mate
- NS Níquel Satinado
- PL Plata

Ref.	mm (centr.)	CB	CI	CS	CU	LM	NM	PB	
<b>C302</b>	150 (ROSETA)								5
<b>C302</b>	150 (PLACA)								2

Ref.	mm (centr.)	AN	CI	CU	NM	PB	PL	
<b>EQ-M890</b>	220							2

Porcelana craquelé

Ref.	mm (centr.)	AN	CI	CU	NM	PB	PL	
<b>EQ-M891</b>	220							2

Porcelana beige

Ref.	mm (centr.)	AN	CI	CU	NM	PB	PL	
<b>EQ-M892</b>	220							2

Porcelana blanca



**C302** LAT

**EQ-M890** LAT



**EQ-M891** LAT



**EQ-M892** LAT







Ref.	mm (entre cent.)	CB	CC	CI	CS	LM	NM	PB	
<b>C307</b>	200								2

Ref.	mm (entre cent.)	CB	CC	CI	CS	LM	NM	PB	
<b>C308</b>	200								2

Ref.	mm (entre cent.)	CB	CC	CI	CU	CS	LM	NM	PB	
<b>C309</b>	200									2

Ref.	mm (entre cent.)	AN	CB	CI	CS	CU	LM	MR	NE	NM	PB	PL	
<b>C310</b>	200												5
<b>C312</b>	160												10

**C310** LAT  
**C312** LAT

JANDEL ORIGINAL

- AN Anticato
- ANTR Antracita
- BL Blanco
- CB Cromo Brillo
- CC Cromo Combinado
- CI Cuero Inglés
- CS Cromo Satinado
- CU Cuero
- LM Latón Mate
- MR Marrón
- NE Negro
- NM Níquel Mate
- NMM Níquel Mate Mate
- NM.OP Níq. Mat. Opaco
- NS Níquel Satinado
- PB Pulido Brillo
- PS Pulido Satin.
- PL Plata
- PVLML PVD Lat. Mate



**C311** LAT





**C313** LAT



**C316** LAT

Ref.	mm (entre cent.)	AN	CB	CI	CS	CU	LM	MR	NM	PB	
<b>C311</b>	200										10

Ref.	mm (entre cent.)	CB	CI	CS	CU	LM	NM	PB	
<b>C313</b>	200								5

Ref.	mm (entre cent.)	CB	CC	CS	NM	
<b>C316</b>	200					2



**C349** ZK



**C320** LAT

Ref.	mm (entre cent.)	CB	CC	CS	NM	
<b>C320</b>	200					1
	250					1
	300					1
	400					1
	500					1

Ref.	mm (entre cent.)	ANTR	BL	CB	CS	NE	NMM	
<b>C349</b>	200							1

- AN Anticato
- ANTR Antracita
- BL Blanco
- CB Cromo Brillo
- CC Cromo Combinado
- CI Cuero Inglés
- CS Cromo Satinado
- CU Cuero
- LM Latón Mate
- MR Marrón
- NE Negro
- NM Níquel Mate
- NMM Níquel Mate Mate
- NM.OP Níq. Mat. Opaco
- NS Níquel Satinado
- PB Pulido Brillo
- PS Pulido Satin.
- PVL M PVD Lat. Mate
- PL Plata

JANDEL ORIGINAL



**C327** ZK

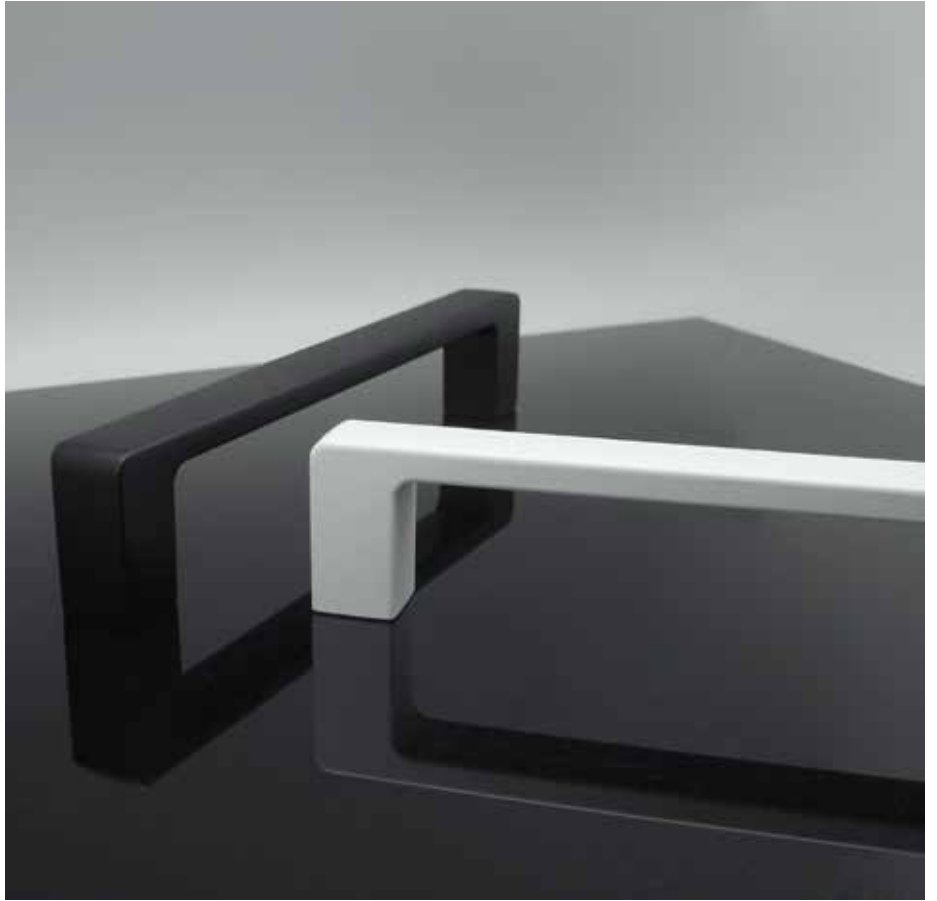

Ref.	mm (entre cent.)	ANTR	BL	CB	CI	CS	LM	NE	NMM	NS	PB	PVLM	
<b>C327</b>	210												2

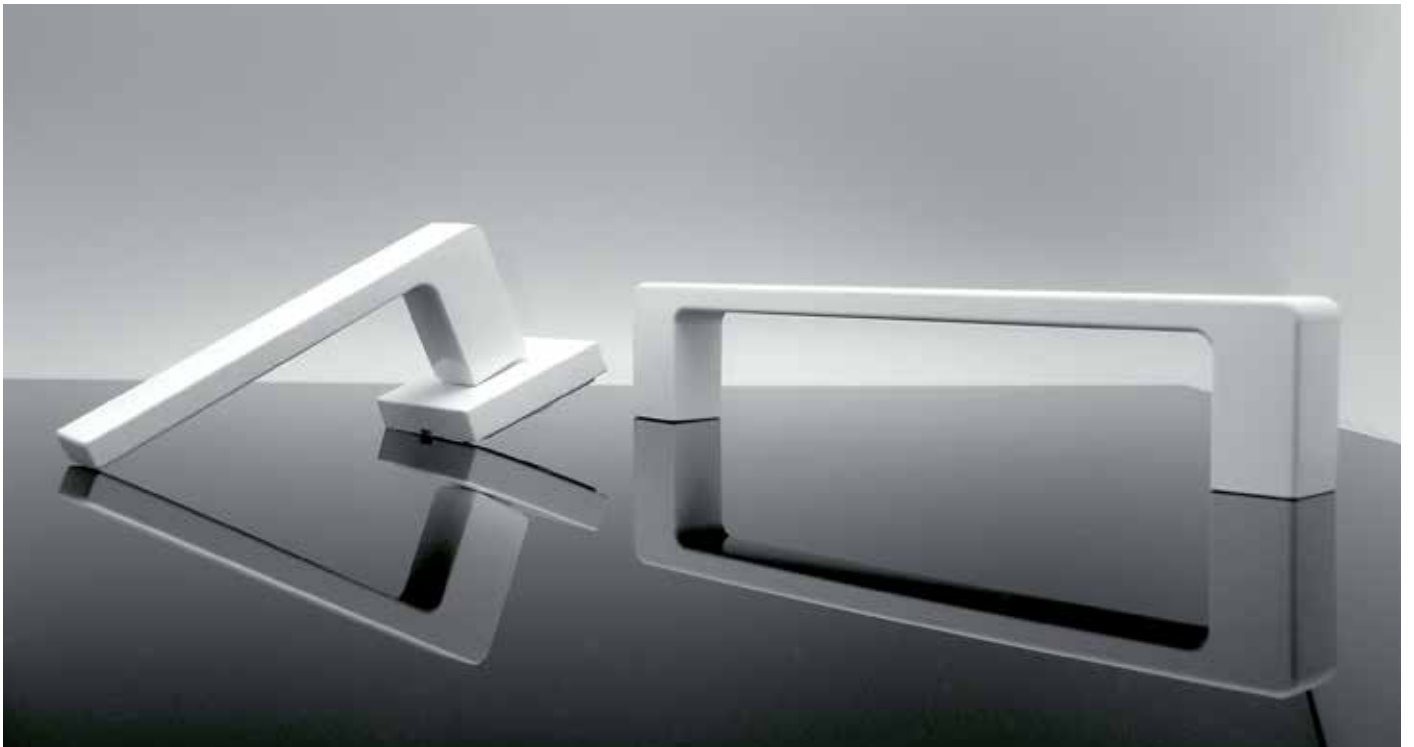



C322 ZK



C326 LAT

JANDEL ORIGINAL

Ref.	mm (entre cent.)	CI	CS	CU	LM	NM	PB	
C322	210							2

Ref.	mm (entre cent.)	CI	CU	LM	MR	NM	PB	PL	
C326	225								2

- AN Anticato
- CB Cromo Brillo
- CS Cromo Satinado
- MR Marrón
- NMM Níquel Mate Mate
- PB Pulido Brillo
- PVLML PVD Lat. Mate
- ANTR Antracita
- CC Cromo Combinado
- CU Cuero
- NE Negro
- NM.OP Níq. Mat. Opaco
- PS Pulido Satin.
- BL Blanco
- CI Cuero Inglés
- LM Latón Mate
- NM Níquel Mate
- NS Níquel Satinado
- PL Plata





**C359** ZK

Ref.	mm (entre cent.)	AN	CI	NE	PL	
<b>C359</b>	220	21.89	21.89	21.89	21.89	2



**C800** LAT

Ref.	mm (entre cent.)	CI	NM	PS	
<b>C800</b>	280x50	39.60	44.20	39.60	2

JANDEL ORIGINAL

- AN Anticato
- ANTR Antracita
- BL Blanco
- CB Cromo Brillo
- CC Cromo Combinado
- CI Cuero Inglés
- CS Cromo Satinado
- CU Cuero
- LM Latón Mate
- MR Marrón
- NE Negro
- NM Níquel Mate
- NMM Níquel Mate Mate
- NM.OP Níq. Mat. Opaco
- NS Níquel Satinado
- PB Pulido Brillo
- PS Pulido Satin.
- PL Plata
- PVL M PVD Lat. Mate



Ref.	CI	CU	LM	MR	NM	PB	PL	
<b>CG75</b> LAT								2





















Ref.	CI	LM	NM	PB	
<b>CGKA</b> ZK					2





Ref.	CB	CS	NE	NM	
<b>G13C</b> ZK					2



-  AN Anticato
-  CB Cromo Brillo
-  CS Cromo Satinado
-  MR Marrón
-  NMM Níquel Mate Mate
-  PB Pulido Brillo
-  PVLM PVD Lat. Mate
-  ANTR Antracita
-  CC Cromo Combinado
-  CU Cuero
-  NE Negro
-  NM.OP Níq. Mat. Opaco
-  PS Pulido Satin.
-  BL Blanco
-  CI Cuero Inglés
-  LM Latón Mate
-  NM Níquel Mate
-  NS Níquel Satinado
-  PL Plata



Ref.	mm	PVD	
<b>SV-105P</b>	Ø85 (base)		1

ZK



Ref.	mm	CI	CU	LM	NM	PS	
<b>C207</b>	Ø90 (base)						1

LAT



Ref.	mm	CI	CU	PS	
<b>C208</b>	Ø85 (base)				1

LAT



Ref.	mm	BL	LM	NE	NS	PB	
<b>EQ-1085</b>	Ø85 (base)						1

LAT



Ref.	mm	CS	CU	NM	PB	
<b>EQ-1095</b>	Ø85 (base)					1

LAT

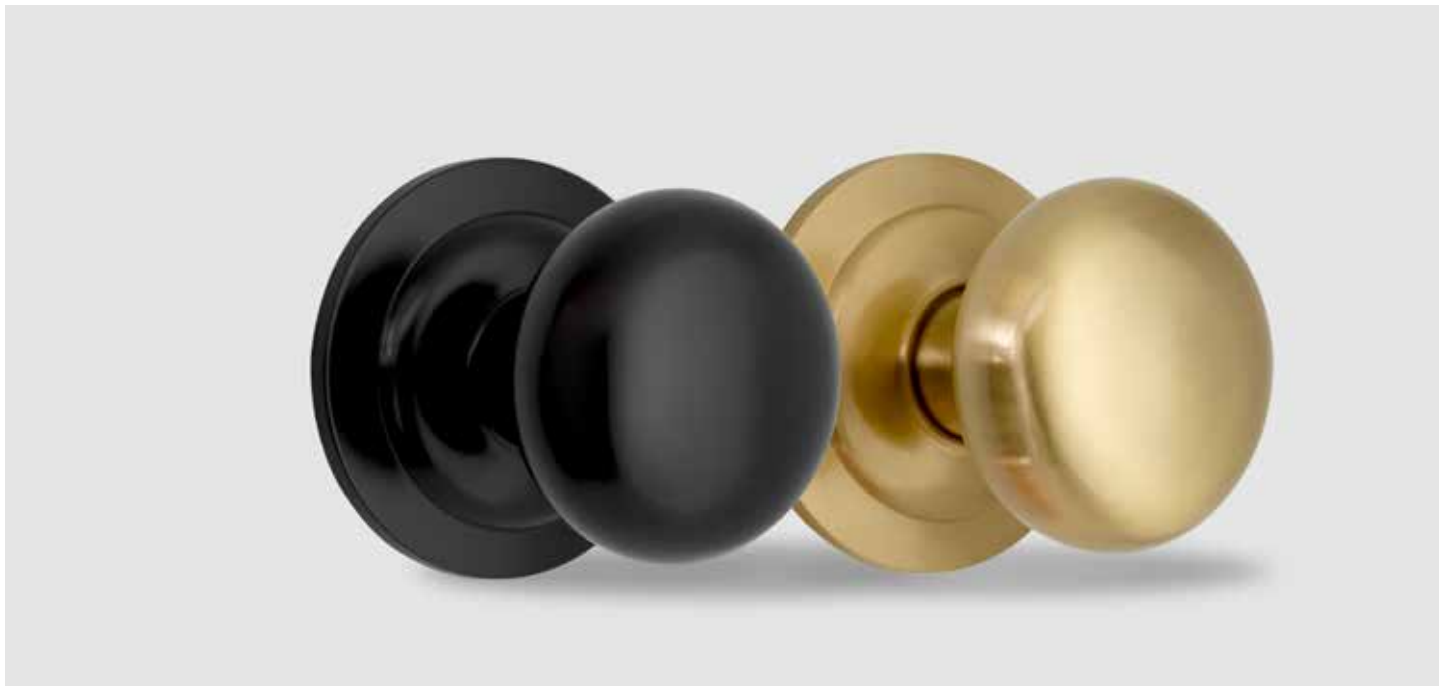

- AN Anticato
- ANTR Antracita
- BL Blanco
- CB Cromo Brillo
- CC Cromo Combinado
- CI Cuero Inglés
- CS Cromo Satinado
- CU Cuero
- LM Latón Mate
- MR Marrón
- NE Negro
- NM Níquel Mate
- NMM Níquel Mate Mate
- NM.OP Níq. Mat. Opaco
- NS Níquel Satinado
- PB Pulido Brillo
- PS Pulido Satin.
- PL Plata
- PVLML PVD Lat. Mate



Ref.	mm	CB	CS	LM	NE	NM	PB	
<b>C210</b>	Ø67 (Ø38 base)							1

LAT























Ref.	mm	CB	CI	CS	LM	NE	NM	PB	
<b>C209</b>	67x67 50x50 (base)								1

LAT



-  AN Anticato
-  CB Cromo Brillo
-  CS Cromo Satinado
-  MR Marrón
-  NMM Níquel Mate Mate
-  PB Pulido Brillo
-  PVLM PVD Lat. Mate
-  ANTR Antracita
-  CC Cromo Combinado
-  CU Cuero
-  NE Negro
-  NM.OP Níq. Mat. Opaco
-  PS Pulido Satin.
-  BL Blanco
-  CI Cuero Inglés
-  LM Latón Mate
-  NM Níquel Mate
-  NS Níquel Satinado
-  PL Plata



Ref.	mm	ANT	CC	CI	CS	CU	LM	MR	PL	
<b>C605</b>	Ø50									10

LAT



Ref.	mm	ANT	CC	CI	CS	CU	LM	MR	PL	
<b>C606</b>	Ø50									10

LAT



Ref.	mm	AN	CB	CI	CS	CU	LM	MR	NS	PB	PL	
<b>SV-BR25</b>	Ø50											10

ZK



Ref.	mm	AN	CB	CI	CS	CU	LM	MR	NS	PB	PL	
<b>EQ-285Z</b>	Ø50											10

ZK



Ref.	mm	ANT	CC	CI	CU	CS	LM	MR	PL	
<b>C608</b>	Ø50									5

LAT



Ref.	mm	AN	BL	CB	CI	CS	CU	LM	NE	NS	PB	PL	
<b>SV-CR50</b>	Ø50												2

ZK



### Bocallave redonda de seguridad

Ref.	mm	AN	ANTR	BL	CB	CI	CS	CU	LM	MR	NE	NM	NMM	PB	PL	
<b>C630</b>	Ø50															10

LAT



Ref.	mm	ANTR	BL	CB	CI	CS	LM	NE	NM	NMM	PVLM	
<b>12BY</b>	Ø50											10

ZK

- AN Anticato
- CB Cromo Brillo
- CS Cromo Satinado
- MR Marrón
- NMM Níquel Mate Mate
- PB Pulido Brillo
- PVLM PVD Lat. Mate
- ANTR Antracita
- CC Cromo Combinado
- CU Cuero
- NE Negro
- NM.OP Níq. Mat. Opaco
- PS Pulido Satin.
- BL Blanco
- CI Cuero Inglés
- LM Latón Mate
- NM Níquel Mate
- NS Níquel Satinado
- PL Plata



Ref.	mm	AN	ANTR	BL	CB	CI	CS	CU	LM	NE	NMM	NS	PB	PL	PVLM	
<b>SV-495</b>	Ø35															5

ZK







Ref.	mm	CB	CI	CS	LM	NM	PB	
<b>C611</b>	50X50							10

LAT



Ref.	mm	ANTR	BL	CB	CI	CS	LM	NE	NM	NMM	PVLM	
<b>34BY</b>	50X50											10

ZK



**Bocallave cuadrada de seguridad**

Ref.	mm	ANTR	BL	CB	CI	CS	LM	NE	NM	NMM	PB	
<b>C635</b>	50X50											10

LAT



Ref.	BL	CB	CI	CS	CU	LM	NE	NM	PB	
<b>C902</b>										20

ZK

- AN Anticato
- CB Cromo Brillo
- CS Cromo Satinado
- MR Marrón
- NMM Níquel Mate Mate
- PB Pulido Brillo
- PVLM PVD Lat. Mate
- ANTR Antracita
- CC Cromo Combinado
- CU Cuero
- NE Negro
- NM.OP Níq. Mat. Opaco
- PS Pulido Satin.
- BL Blanco
- CI Cuero Inglés
- LM Latón Mate
- NM Níquel Mate
- NS Níquel Satinado
- PL Plata



Ref.	mm	ANTR	BL	CB	CI	CS	LM	NE	NM	NMM	
<b>12WC</b>	Ø50										5

ZK



Ref.	mm	CB	CC	CI	CS	LM	NM	PB	
<b>C621</b>	Ø50								5

ZK



Ref.	mm	BL	CB	CI	CS	LM	NE	NM	NMM	
<b>34WC</b>	Ø50									5

ZK



Ref.	mm	ANTR	BL	CB	CI	CS	LM	NE	NMM	NS	
<b>SVCC35</b>	Ø35										5

ZK



Ref.	mm	AN	ANTR	CB	CI	CS	CU	LM	MR	NM	NMOP	PB	PL	
<b>7610</b>	Ø56 Ø48 (interior)													5

ZK



Ref.	mm	ANTR	CB	CI	CS	LM	NM	NMOP	PB	
<b>7630</b>	∅56 Ø48 (interior)									5

ZK



7510



7530

Ref.	mm	ANTR	BL	CB	CI	CS	CU	EFLM	LM	MR	NE	NM	NM.OP	PB	PL	
<b>7510</b>	Ø56 Ø48 (interior)															1
<b>7530</b>	56x56 Ø48 (interior)															1

ZK

- AN Anticato
- CB Cromo Brillo
- CS Cromo Satinado
- MR Marrón
- NMM Níquel Mate Mate
- PB Pulido Brillo
- PVLM PVD Lat. Mate
- ANTR Antracita
- CC Cromo Combinado
- CU Cuero
- NE Negro
- NM.OP Níq. Mat. Opaco
- PS Pulido Satin.
- BL Blanco
- CI Cuero Inglés
- LM Latón Mate
- NM Níquel Mate
- NS Níquel Satinado
- PL Plata



Ref.	mm	CB	CI	CS	CU	LM	NM	PB	
<b>C410</b>	129x34								10
<b>C420</b>	79x34								10

LAT



Ref.	Medidas	CI	NM	PS	
<b>C450</b>	137x33				10
<b>C460</b>	87x33				10

LAT



**NEW**

Ref.	mm	CI	
<b>T490</b> (porc. craquelé)	128x33		20
<b>T491</b> (porc. beige)	128x33		20
<b>T492</b> (porc. blanca)	128x33		20
<b>A490</b> (porc. craquelé)	88x33		20
<b>A491</b> (porc. beige)	88x33		20
<b>A492</b> (porc. blanca)	88x33		20

LAT



- AN Anticato
- ANTR Antracita
- BL Blanco
- CB Cromo Brillo
- CC Cromo Combinado
- CI Cuero Inglés
- CS Cromo Satinado
- CU Cuero
- LM Latón Mate
- MR Marrón
- NE Negro
- NM Níquel Mate
- NMM Níquel Mate Mate
- NM.OP Níq. Mat. Opaco
- NS Níquel Satinado
- PB Pulido Brillo
- PS Pulido Satin.
- PL Plata
- PVLM PVD Lat. Mate

JANDEL ORIGINAL

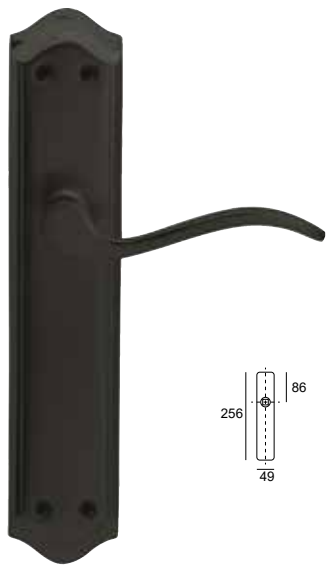

AL

Ref.	Denominación	mm	NE		
EQ-202	Jgo. Manivela	256x49		2	20
EQ-M202	Manillón	256x49		4	40
EQ-L202	Placa limpieza	256x49		10	100
EQ-C202	Asa corta c/placa	256x49		4	40
EQ-T202	Tirador armario	123x35		20	200
EQ-A202	Tirador maletero	83x35		20	200
EQ-P202	Placa pomo fijo	256x49		2	40
EQ-P202MV	Placa pomo móvil	256x49		2	40

AL

Ref.	Denominación	mm	PS		
EQ-203	Jgo. Manivela	256x49		2	20
EQ-M203	Manillón	256x49		4	40
EQ-L203	Placa limpieza	256x49		10	100
EQ-C203	Asa corta c/placa	256x49		4	40
EQ-T203	Tirador armario	123x35		20	200
EQ-A203	Tirador maletero	83x35		20	200
EQ-P203	Placa pomo fijo	256x49		2	40
EQ-P203MV	Placa pomo móvil	256x49		2	40

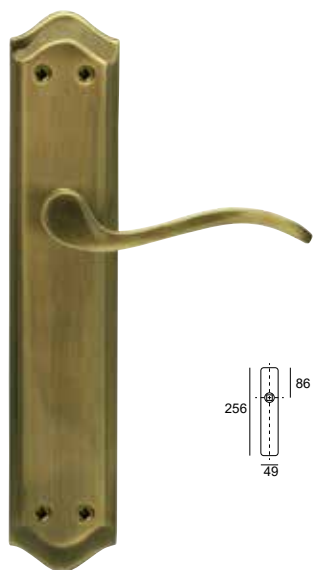

AL

Ref.	Denominación	mm	CU		
EQ-204	Jgo. Manivela	256x49		2	20
EQ-M204	Manillón	256x49		4	40
EQ-L204	Placa limpieza	256x49		10	100
EQ-C204	Asa corta c/placa	256x49		4	40
EQ-T204	Tirador armario	123x35		20	200
EQ-A204	Tirador maletero	83x35		20	200
EQ-P204	Placa pomo fijo	256x49		2	40
EQ-P204MV	Placa pomo móvil	256x49		2	40

AL

Ref.	Denominación	mm	NS		
EQ-205	Jgo. Manivela	256x49		2	20
EQ-M205	Manillón	256x49		4	40
EQ-L205	Placa limpieza	256x49		10	100
EQ-C205	Asa corta c/placa	256x49		4	40
EQ-T205	Tirador armario	123x35		20	200
EQ-A205	Tirador maletero	83x35		20	200
EQ-P205	Placa pomo fijo	256x49		2	40
EQ-P205MV	Placa pomo móvil	256x49		2	40

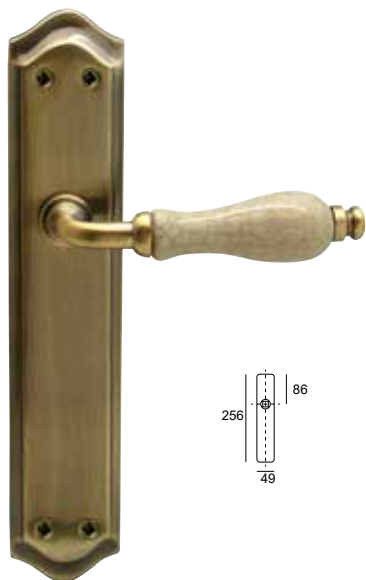

AL / LAT

Ref.	Denom.	AN	CI	CU	NS	PL	PS		
EQ-206	Jgo. Man. CRAQUELÉ							1	20
	Jgo. Man. BEIGE							1	20
	Jgo. Man. BLANCA							1	20
EQ-T290	Tirador armario CRAQUELÉ							20	200
EQ-T291	Tirador armario BEIGE							20	200
EQ-T292	Tirador armario BLANCA							20	200
EQ-A290	Tirador malet. CRAQUELÉ							20	200
EQ-A291	Tirador malet. BEIGE							20	200
EQ-A292	Tirador malet. BLANCA							20	200

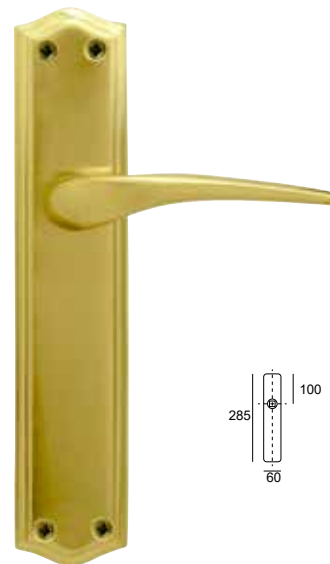

ZK

Ref.	Denominación	mm	PS		
EQ-207	Jgo. Manivela	285x60		1	20
EQ-M207	Manillón	285x60		2	40
EQ-L207	Placa limpieza	285x60		10	100
EQ-C207	Asa corta c/placa	285x60		4	40
EQ-T203	Tirador armario	123x35		20	200
EQ-A203	Tirador maletero	83x35		20	200
EQ-P207	Placa pomo fijo	285x60		2	40
EQ-P207MV	Placa pomo móvil	285X60		2	40

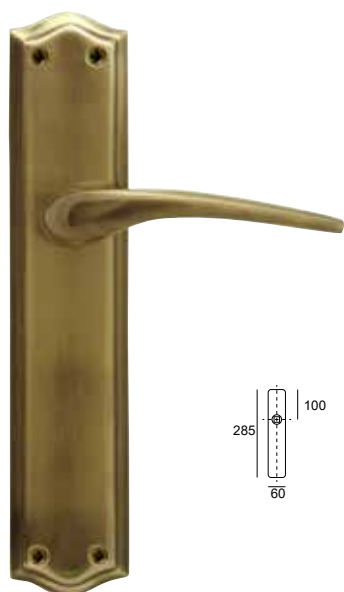

ZK

Ref.	Denominación	mm	CU		
EQ-208	Jgo. Manivela	285x60		1	20
EQ-M208	Manillón	285x60		2	40
EQ-L208	Placa limpieza	285x60		10	100
EQ-C208	Asa corta c/placa	285x60		4	40
EQ-T204	Tirador armario	123x35		20	200
EQ-A204	Tirador maletero	83x35		20	200
EQ-P208	Placa pomo fijo	285x60		2	40
EQ-P208MV	Placa pomo móvil	285X60		2	40

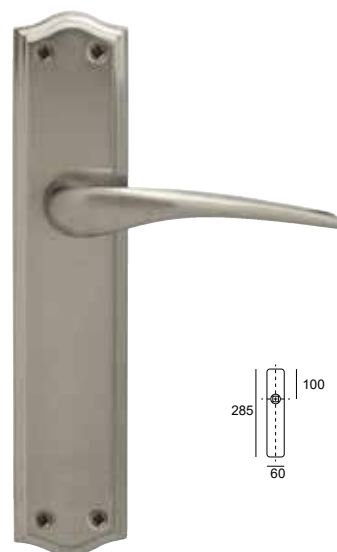

ZK

Ref.	Denominación	mm	NS		
EQ-209	Jgo. Manivela	285x60		1	20
EQ-M209	Manillón	285x60		2	40
EQ-L209	Placa limpieza	285x60		10	100
EQ-C209	Asa corta c/placa	285x60		4	40
EQ-T205	Tirador armario	123x35		20	200
EQ-A205	Tirador maletero	83x35		20	200
EQ-P209	Placa pomo fijo	285x60		2	40
EQ-P209MV	Placa pomo móvil	285X60		2	40

- AN Anticato
- CB Cromo Brillo
- CS Cromo Satinado
- NMM Níq. Mate Mate
- PB Pulido Brillo
- ANTR Antracita
- CI Cuero Inglés
- LM Latón Mate
- NS Níquel Satinado
- PL Plata
- BL Blanco
- CU Cuero
- NE Negro
- NS/NB Níq. Sat / Níq. Br.
- PS Pulido Satin.



JANDEL EQUAL

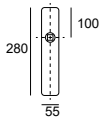

ZK

Ref.	Denominación	mm	CU	NS	PS		
EQ-210	Jgo. Manivela	280x55				1	20
EQ-M210	Manillón	280x55				2	40
EQ-L210	Placa limpieza	280x55				10	100
EQ-C210	Asa corta c/placa	280x55				4	40
EQ-P210	Placa pomo fijo	280x55				2	40
EQ-T150	Tirador armario	129x34				20	200
EQ-A150	Tiradro maletero	79x34				20	200
EQ-P210MV	Placa pomo móvil	280x55				2	40

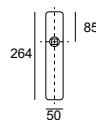

AL

Ref.	Denominación	mm	CI	NS	PS		
EQ-868	Jgo. Manivela	264x50				2	20
EQ-M868	Manillón	264x50				2	40
EQ-L868	Placa limpieza	264x50				10	100
EQ-C868	Asa corta c/placa	264x50				4	40
EQ-T203	Tirador armario	125x35				20	200
EQ-A203	Tirador maletero	83x35				20	200
EQ-P868	Placa pomo fijo	264x50				2	40
EQ-P868MV	Placa pomo móvil	264x50				2	40





JANDEL EQUAL

- AN Anticato
- CB Cromo Brillo
- CS Cromo Satinado
- NMM Níq. Mate Mate
- PB Pulido Brillo
- ANTR Antracita
- CI Cuero Inglés
- LM Latón Mate
- NS Níquel Satinado
- PL Plata
- BL Blanco
- CU Cuero
- NE Negro
- NS/NB Níq. Sat / Níq. Br.
- PS Pulido Satin.





**EQ-R204** AL

mm	CU		
Ø 50		1	20



**EQ-R150** AL

mm	CU	LM	NE	NS	PB		
Ø 50						1	20



**EQ-R200** AL

mm	BL	LM	NE	NS	NS/NB		
Ø 50						1	20



**SV-R250** AL

mm	NS/NB		
Ø 50		1	20

● AN Anticato  
● ANTR Antracita  
○ BL Blanco

● CB Cromo Brillo  
● CI Cuero Inglés  
● CU Cuero



● CS Cromo Satinado  
● LM Latón Mate  
● NE Negro

● NMM Níq. Mate Mate  
● NS Níquel Satinado  
● NS/NB Níq. Sat / Níq. Br.

● PB Pulido Brillo  
● PL Plata  
● PS Pulido Satin.





**SV-R300** AL

mm	NS		
Ø 50		1	20





**SV-R333** AL

mm	NE		
Ø 50		1	20

JANDEL EQUAL





**SV-R350** AL

mm	NS/NB		
Ø 50		1	20





**SV-R600** AL

mm	ANTR	BL	NE	NS	NS/ NB		
Ø 50						1	20





NEW

**SV-R700** AL

mm	ANTR	NE	NS		
Ø 50				1	20





**SV-R800** AL

mm	NS		
Ø 50		1	20



NEW

**SV-R850** AL



mm	ANTR	LM	NE	NS		
Ø 50					1	20



NEW

Tapa Pomos

**SV-R655** AL

mm	CU	LM	NE	NS	PB		
Ø 65						1	20

● AN Anticato  
● ANTR Antracita  
○ BL Blanco

● CB Cromo Brillo  
● CI Cuero Inglés  
● CU Cuero

● CS Cromo Satinado  
● LM Latón Mate  
● NE Negro

● NMM Níq. Mate Mate  
● NS Níquel Satinado  
● NS/NB Níq. Sat / Níq. Br.

● PB Pulido Brillo  
● PL Plata  
● PS Pulido Satin.

NEW



**EQ-C150** AL

mm	NS		
50x50		1	20



**SV-C200** AL

mm	NE	NS		
50x50			1	20

NEW



**SV-C350** AL

mm	NS/NB		
50x50		1	20



**SV-C400** AL

mm	ANTR	BL	LM	NE	NS	NS/NB		
50x50							1	20



**SV-C700** AL

mm	NE	NS		
50x50			1	20



**SV-C750** AL

mm	NS		
50x50		1	20



JANDEL EQUAL

- |                  |                   |                     |                             |                    |
|------------------|-------------------|---------------------|-----------------------------|--------------------|
| ● AN Anticato    | ● CB Cromo Brillo | ● CS Cromo Satinado | ● NMM Níq. Mate Mate        | ● PB Pulido Brillo |
| ● ANTR Antracita | ● CI Cuero Inglés | ● LM Latón Mate     | ● NS Níquel Satinado        | ● PL Plata         |
| ○ BL Blanco      | ● CU Cuero        | ● NE Negro          | ● NS/NB Níq. Sat / Níq. Br. | ● PS Pulido Satin. |

MANILLAS EN NEGRO



EQ-R150



SV-R700



EQ-R200



SV-R850



SV-R333



SV-C200



SV-R600



SV-C400



SV-R655



SV-C700



## MANILLAS EN LATÓN MATE



EQ-R150



EQ-R200



SV-C400



SV-R850

- AN Anticato
- ANTR Antracita
- BL Blanco

- CB Cromo Brillo
- CI Cuero Inglés
- CU Cuero



- CS Cromo Satinado
- LM Latón Mate
- NE Negro

- NMM Níq. Mate Mate
- NS Níquel Satinado
- NS/NB Níq. Sat / Níq. Br.

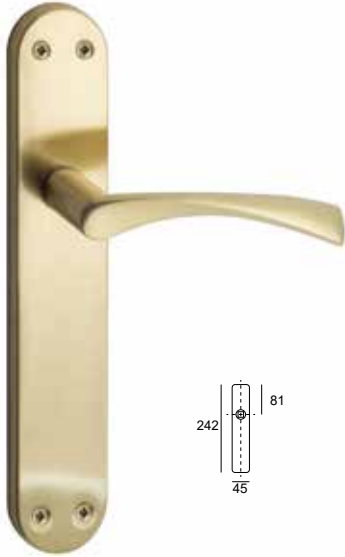
- PB Pulido Brillo
- PL Plata
- PS Pulido Satin.





AL

Ref.	CU	LM	NE	NS	PB		
<b>SV-P150</b>						2	20



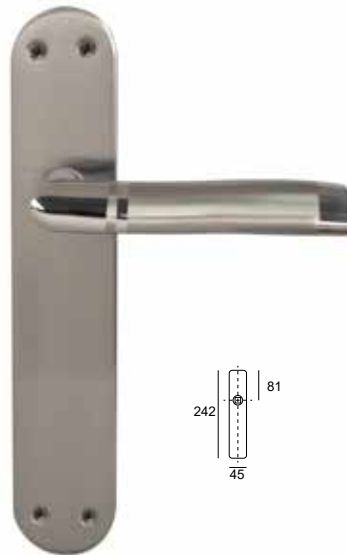

AL

Ref.	BL	LM	NE	NS		
<b>SV-P200</b>					2	20





AL

Ref.	NS/NB		
<b>SV-P250</b>		2	20



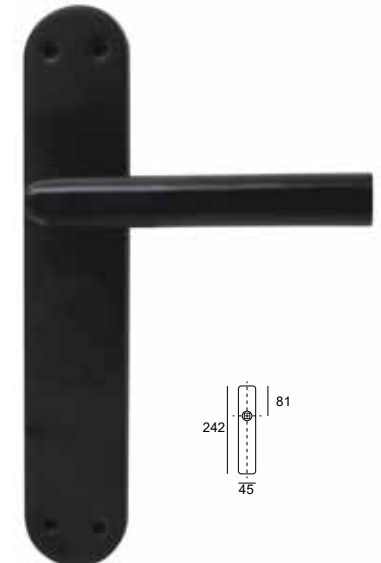

AL

Ref.	NS		
<b>SV-P300</b>		2	20



AL

Ref.	NE		
<b>SV-P333</b>		1	20

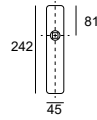

AL

Ref.	NS/NB		
<b>SV-P350</b>		2	20

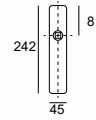

AL

Ref.	ANTR	BL	NE	NS		
<b>SV-P600</b>					1	20

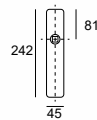

NEW

AL

Ref.	ANTR	LM	NE	NS		
<b>SV-P850</b>					1	20

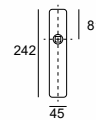

NEW

AL

Ref.	ANTR	NE	NS		
<b>SV-P700</b>				1	20





- AN Anticato
- CB Cromo Brillo
- CS Cromo Satinado
- NMM Niq. Mate Mate
- PB Pulido Brillo
- ANTR Antracita
- CI Cuero Inglés
- LM Latón Mate
- NS Níquel Satinado
- PL Plata
- BL Blanco
- CU Cuero
- NE Negro
- NS/NB Niq. Sat / Niq. Br.
- PS Pulido Satin.

JANDEL EQUAL





AL

Ref.	NE	NS		
<b>SV-PC20</b>			1	20

NEW





AL

Ref.	NS/NB		
<b>SV-PC35</b>		1	20





AL

Ref.	NE	NS		
<b>SV-PC70</b>			1	20



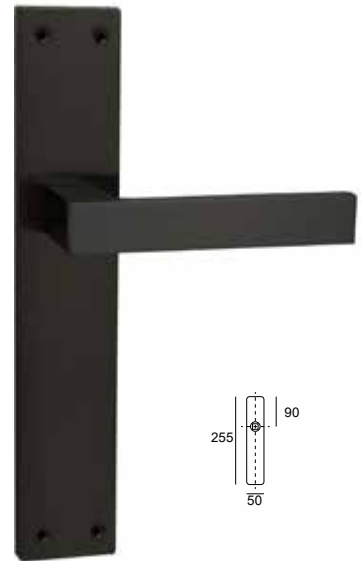

AL

Ref.	NS		
<b>SV-PC75</b>		1	20



AL

Ref.	ANTR	BL	LM	NE	NS	NS/NB		
<b>SV-P400</b>							1	20



JANDEL EQUAJ

● AN Anticato  
● ANTR Antracita  
○ BL Blanco

● CB Cromo Brillo  
● CI Cuero Inglés  
● CU Cuero

● CS Cromo Satinado  
● LM Latón Mate  
● NE Negro

● NMM Níq. Mate Mate  
● NS Níquel Satinado  
● NS/NB Níq. Sat / Níq. Br.

● PB Pulido Brillo  
● PL Plata  
● PS Pulido Satin.

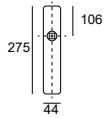

ZK

Ref.	NE		
<b>SV-P398</b>		1	20

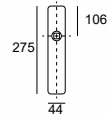

ZK

Ref.	NE		
<b>SV-P500</b>		1	20

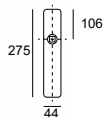

ZK

Ref.	NE		
<b>SV-PP50</b>		2	40

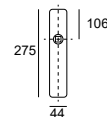

ZK

Ref.	NE		
<b>SV-M500</b>		5	40



JANDEL EQUAL

- |                  |                   |                     |                             |                    |
|------------------|-------------------|---------------------|-----------------------------|--------------------|
| ● AN Anticato    | ● CB Cromo Brillo | ● CS Cromo Satinado | ● NMM Niq. Mate Mate        | ● PB Pulido Brillo |
| ● ANTR Antracita | ● CI Cuero Inglés | ● LM Latón Mate     | ● NS Níquel Satinado        | ● PL Plata         |
| ○ BL Blanco      | ● CU Cuero        | ● NE Negro          | ● NS/NB Niq. Sat / Niq. Br. | ● PS Pulido Satin. |



AL

Ref.	mm (centr.)	CU	LM	NE	NS	PB	
<b>SV-M150</b>	200						1



AL

Ref.	mm (centr.)	NS/NB	
<b>SV-M350</b>	180		1



AL

Ref.	mm (centr.)	BL	LM	NE	NS	NS/NB	
<b>SV-M200</b>	200						1





Ref.	mm (entre cent.)	INOX	
EQ-M802 (Ø 25)	225 (200)		2
	325 (300)		2
	625 (600)		2
	925 (900)		2
	1225 (1200)		2

AL

INOX

Ref.	mm (centr.)	ANTR	BL	CB	CS	LM	NE	NS	
SV-M335	200								1



AL

Ref.	mm (centr.)	BL	NE	NS	
SV-M600	200				1

- AN Anticato
- ANTR Antracita
- BL Blanco
- CB Cromo Brillo
- CI Cuero Inglés
- CU Cuero
- CS Cromo Satinado
- LM Latón Mate
- NE Negro
- NMM Níq. Mate Mate
- NS Níquel Satinado
- NS/NB Níq. Sat / Níq. Br.
- PB Pulido Brillo
- PL Plata
- PS Pulido Satin.



NEW

AL

Ref.	mm (centr.)	NS	
<b>SV-MC15</b>	200		1



AL

Ref.	mm (centr.)	NE	NS	
<b>SV-MC20</b>	200			1



NEW

AL

Ref.	mm (centr.)	NS/NB	
<b>SV-MC35</b>	200		1



AL

Ref.	mm (centr.)	BL	NE	NS	NS/NB	
<b>SV-M400</b>	200					1



JANDEL EQUAL

- |                  |                   |                     |                             |                    |
|------------------|-------------------|---------------------|-----------------------------|--------------------|
| ● AN Anticato    | ● CB Cromo Brillo | ● CS Cromo Satinado | ● NMM Níq. Mate Mate        | ● PB Pulido Brillo |
| ● ANTR Antracita | ● CI Cuero Inglés | ● LM Latón Mate     | ● NS Níquel Satinado        | ● PL Plata         |
| ○ BL Blanco      | ● CU Cuero        | ● NE Negro          | ● NS/NB Níq. Sat / Níq. Br. | ● PS Pulido Satin. |

\* Medidas especiales consultar con el departamento comercial



INOX

Ref.	A (B)	NE	
<b>EQ-M800</b> Ø30 mm	300 (210)		2
	400 (300)		2
	500 (300)		2
	600 (400)		2
	800 (600)		2
	1200 (900)		2
	1500 (1300)		1
	1800 (1500)		1

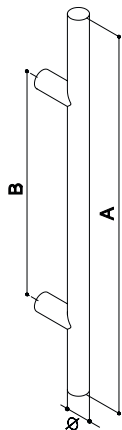

INOX

Ref.	A (B)	NE	
<b>EQ-M810</b> Ø30 mm Desplazado 45°	300 (210)		2
	400 (300)		2
	500 (300)		2
	600 (400)		2
	800 (600)		2
	1200 (900)		2

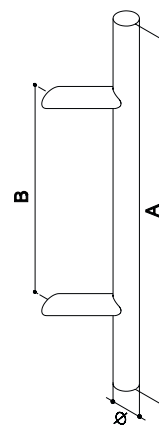

INOX

Ref.	A (B)	NE	
<b>EQ-M831</b> ■25 x 25 mm	300 (210)		2
	400 (300)		2
	500 (300)		2
	600 (400)		2
	800 (600)		2
	1200 (900)		2
	1500 (1300)		1
	1800 (1500)		1

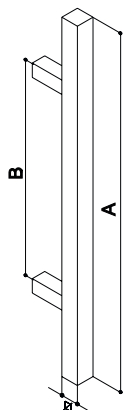

NEW

INOX

Ref.	A (B)	NE	
<b>SV-M861</b> ■25 x 25 mm Desplazado 45°	400 (210)		
	500 (300)		
	600 (400)		
	700 (500)		
	800 (600)		
	1200 (900)		

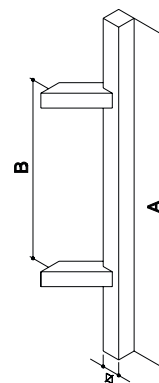



- AN Anticato
- ANTR Antracita
- BL Blanco
- CB Cromo Brillo
- CI Cuero Inglés
- CU Cuero
- CS Cromo Satinado
- LM Latón Mate
- NE Negro
- NMM Níq. Mate Mate
- NS Níquel Satinado
- NS/NB Níq. Sat / Níq. Br.
- PB Pulido Brillo
- PL Plata
- PS Pulido Satin.

JANDEL EQUAL





INOX

Ref.	A (B)	NE	
<b>SV-M360</b> (■ 20)	220 (200)		2
	270 (250)		2
	320 (300)		2
	420 (400)		2
	470 (450)		2

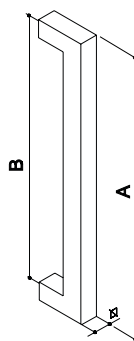

NEW

INOX

Ref.	A (B)	NE	
<b>EQ-M802K</b> (■ 25)	225 (200)		2
	325 (300)		2
	625 (600)		2
	925 (900)		2
	1225 (1200)		2

● AN Anticato  
● ANTR Antracita  
○ BL Blanco

● CB Cromo Brillo  
● CI Cuero Inglés  
● CU Cuero

● CS Cromo Satinado  
● LM Latón Mate  
● NE Negro

● NMM Níq. Mate Mate  
● NS Níquel Satinado  
● NS/NB Níq. Sat / Níq. Br.

● PB Pulido Brillo  
● PL Plata  
● PS Pulido Satin.



JANDEL EQUAL

Ref.	mm	BL	CU	LM	NE	NS	PB	
<b>SV-MP15</b>	242x45							2
<b>SV-PP15</b>	242x45							2
<b>SV-C150</b>	242x45							4

AL / LAT





- |                  |                   |                     |                             |                    |
|------------------|-------------------|---------------------|-----------------------------|--------------------|
| ● AN Anticato    | ● CB Cromo Brillo | ● CS Cromo Satinado | ● NMM Níq. Mate Mate        | ● PB Pulido Brillo |
| ● ANTR Antracita | ● CI Cuero Inglés | ● LM Latón Mate     | ● NS Níquel Satinado        | ● PL Plata         |
| ○ BL Blanco      | ● CU Cuero        | ● NE Negro          | ● NS/NB Níq. Sat / Níq. Br. | ● PS Pulido Satin. |



ZK

Ref.	Ø mm	ANTR	BL	CU	LM	NE	NS	PB	
<b>EQ-285Z</b>	50								10



ZK

Ref.	Ø mm	ANTR	BL	CU	LM	NE	NS	PB	
<b>SV-BR25</b>	50								10

INOX

Ref.	Ø mm	NE	
<b>SV-B304</b>	52		10
<b>SV-B305</b>	52		10



ZK

Ref.	Ømm	ANTR	BL	CU	LM	NE	NS	PB	
<b>SV-CR50</b>	50								2

ZK

Ref.	Ømm	ANTR	BL	CU	LM	NE	NMM	NS	PB	
<b>SV-495</b>	35									5



ZK

Ref.	AN	ANTR	BL	CI	CS	CU	LM	NE	NMM	NS	PB	PL	
<b>EQ-1197</b>													10



ZK

Ref.	mm	ANTR	BL	CB	CS	NE	NS	NS/NB	
<b>SV-BC15</b>	50x50								10
<b>SV-BC25</b>	50x50								10



INOX

Ref.	mm	NE	
<b>SV-B303</b>	50x50		10
<b>SV-B308</b>	50x50		10

ZK

Ref.	mm	ANTR	BL	CB	CI	CS	LM	NE	NMM	NS	
<b>SV-CC35</b>	35x35										5



ZK

Ref.	mm	ANTR	BL	CB	CS	NE	NS	NS/NB	
<b>SV-CC50</b>	50x50								2



ZK

Ref.	BL	CB	CI	CS	CU	LM	NE	NS	PB	
<b>C902</b>										20

- AN Anticato
- ANTR Antracita
- BL Blanco

- CB Cromo Brillo
- CI Cuero Inglés
- CU Cuero

- CS Cromo Satinado
- LM Latón Mate
- NE Negro

- NMM Niq. Mate Mate
- NS Níquel Satinado
- NS/NB Niq. Sat / Niq. Br.

- PB Pulido Brillo
- PL Plata
- PS Pulido Satin.



ZK

Ref.	BL	CB	CS	NE	NS	PB	
SVDEDALC						-	20
SVDEDALR							20

ZK

Ref.	ANTR	BL	CB	CS	CU	LM	NE	NS	PB		
SV-CCDR										1	20

Ø56 mm (Ø48 interior)



ZK

Ref.	ANTR	BL	CB	CS	CU	LM	NE	NS	PB		
SV-KITR										1	20

Ø56 mm (Ø48 interior)  
Frontal **16 mm**. Especial para picaporte unificado de 70 mm.



ZK

Ref.	BL	CB	CS	CU	LM	NE	NS	PB		
KITR20									1	20

Ø56 mm (Ø48 interior)  
Frontal **20 mm**. Especial para picaporte unificado de 70 mm.



ZK

Ref.	ANTR	BL	CB	CS	LM	NE	NS		
<b>SV-CCDC</b>								1	20

56 x 56 mm (Ø48 interior)



ZK

Ref.	ANTR	BL	CB	CS	LM	NE	NS		
<b>SV-KITC</b>								1	20

56 x 56 (Ø48 interior)

Frontal **16 mm**. Especial para picaporte unificado de 70 mm.



**NEW**

ZK

ZK

Ref.	BL	CB	CS	NE	NS		
<b>KITC20</b>						1	20

56 x 56 mm (Ø48 interior)

Frontal **20 mm**. Especial para picaporte unificado de 70 mm.

Ref.	NS	
<b>PICOLORO</b>		10

- AN Anticato
- ANTR Antracita
- BL Blanco

- CB Cromo Brillo
- CI Cuero Inglés
- CU Cuero

- CS Cromo Satinado
- LM Latón Mate
- NE Negro

- NMM Níq. Mate Mate
- NS Níquel Satinado
- NS/NB Níq. Sat / Níq. Br.

- PB Pulido Brillo
- PL Plata
- PS Pulido Satin.



Kits corredera con bombillo 40 mm con 3 llaves



ZK

Ref.	mm	CU	NE	NS	PB	
<b>SV-KITB</b>	Ø56 (Ø48 int.)					1

ZK

Ref.	mm	CB	CS	NE	NS	
<b>SV-KITBC</b>	■ 56 (Ø48 int.)					1

JANDEL EQUAL



ZK

Ref.	mm	BL	CU	NE	NS	PB	
<b>PU-47</b>	47						10
<b>PU-70</b>	70						10

ZK

Ref.	mm	CU	LM	NE	NS	
<b>SV-PSMN</b>	Ø70					15



ZK

Ref.	Ø mm	MIXTA	NS	PB	
<b>MR-2542</b>	14(25-42)				12



ZK

Ref.	Ø mm	MIXTA	NE	NS	PB	
<b>MR-3560</b>	14(35-60)					12



ZK

Ref.	Ø mm	NE	NS	
<b>SV-TOPE</b>	22x30			25



AL

Ref.	mm	ANTR	BL	CB	CI	CS	CU	LM	NE	NS	PB	
<b>SV-T150</b>	129x34											20
<b>SV-A150</b>	79x34											20

AL

Ref.	mm	ANTR	BL	CB	CI	CS	LM	NE	NS	PB	
<b>SV-T401</b>	132x38										20
<b>SV-A401</b>	81x34										20

- AN Anticato
- ANTR Antracita
- BL Blanco

- CB Cromo Brillo
- CI Cuero Inglés
- CU Cuero

- CS Cromo Satinado
- LM Latón Mate
- NE Negro

- NMM Níq. Mate Mate
- NS Níquel Satinado
- NS/NB Níq. Sat / Níq. Br.

- PB Pulido Brillo
- PL Plata
- PS Pulido Satin.





ZK

Ref.	mm	ANTR	BL	CU	NE	NS	PB		
<b>PH-100D</b>	100x57x2							20	240
<b>PH-100I</b>	100x57x2							20	240



ZK

Ref.	mm	BL	CU	NE	NS	PB		
<b>PH-95D</b>	95x54x2						20	240
<b>PH-95I</b>	95x54x2						20	240



INOX

Ref.	mm	INOX		
<b>PI-100D</b>	100x57x2		20	240
<b>PI-100I</b>	100x57x2		20	240



INOX

Ref.	mm	INOX		
<b>PI-95D</b>	95x53x2		20	240
<b>PI-95I</b>	95x53x2		20	240





ZK

Ref.	mm	BL	CU	LM	NE		
<b>BH-90CD</b>	90x65x2.5					10	100
<b>BH-90CI</b>	90x65x2.5					10	100
<b>BH-80CD</b>	80x60x2.5	-				10	100
<b>BH-80CI</b>	80x60x2.5	-				10	100



ZK

Ref.	mm	BL	CU	LM	NE		
<b>BH-90RD</b>	90x65x2.5					10	100
<b>BH-90RI</b>	90x65x2.5					10	100



INOX

Ref.	mm	INOX		
<b>BI-90CD</b>	90x65x2.5		10	100
<b>BI-90CI</b>	90x65x2.5		10	100
<b>BI-80CD</b>	80x60x2.5		10	100
<b>BI-80CI</b>	80x60x2.5		10	100



INOX

Ref.	mm	INOX		
<b>BI-90RD</b>	90x65x2.5		10	100
<b>BI-90RI</b>	90x65x2.5		10	100

- AN Anticato
- ANTR Antracita
- BL Blanco
- CB Cromo Brillo
- CI Cuero Inglés
- CU Cuero
- CS Cromo Satinado
- LM Latón Mate
- NE Negro
- NMM Níq. Mate Mate
- NS Níquel Satinado
- NS/NB Níq. Sat / Níq. Br.
- PB Pulido Brillo
- PL Plata
- PS Pulido Satin.

JANDEL EQUAJ



NEW

AL

Ref.	mm	NE	NS	
<b>SV-PR</b>	242x45			10



NEW

AL

Ref.	mm	NE	NS	
<b>SV-PC</b>	255x50			10

● PB Pulido Brillo  
● PS Pulido Satin.  
● NS Níquel Satin.

● CU Cuero  
● CI Cuero Inglés  
● CB Cromo Brillo

● NS/NB Níq. Sat / Níq. Br  
● LM Latón Mate  
● NE Negro

○ BL Blanco  
● CS Cromo Satinado  
● PL Plata

● AN Anticato  
● NMM Níq. Mate Mate

## Accesorios Técnicos

\*Taladro condena y desbloqueo 1€ Neto

\*Taladro bocallave 0,50€ Neto

\*Taladro bocallave cortinilla 2,50€ Neto



8X8

Fijación expositor cuadradillo



Ø8

Fijación expositor roscado pomo

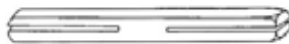

8x85	8x120	8x150	8x200

Cuadradillo fresado de 8 mm

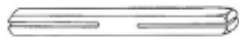

6x80	6x100	6x120

Cuadradillo fresado de 6 mm



de 7 a 6	de 8 a 6	de 8 a 7

Reductor



8x65	8x85

Cuadradillo de expansión



Muelle



Muelle espiral

# LINEA INOX



ELEVADA RESISTENCIA  
A LA CORROSIÓN

JANDEL INOX





Ref.	mm	INOX	NE		
<b>SV-R302</b>	Ø 52			1	40





Ref.	mm	INOX	NE		
<b>SV-X302</b>	60x32			1	40



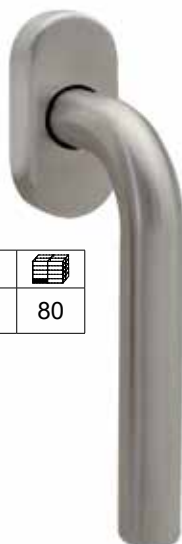

Ref.	mm	INOX	NE		
<b>SV-F302</b>	170x170			1	10



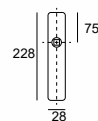

Ref.	mm	INOX	NE		
<b>SV-G302</b>	60x32			2	80



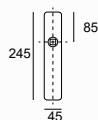

Ref.	INOX	NE		
<b>SV-E302</b>			2	40



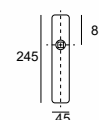

Ref.	INOX	NE		
<b>SV-P301</b>			1	20





Ref.	INOX	NE		
<b>SV-P302</b>			1	20

JANDEL INOX





Ref.	mm	INOX		
<b>SV-R336</b>	Ø 52		1	40





Ref.	mm	INOX		
<b>SV-X336</b>	60x32		1	40





Ref.	mm	INOX		
<b>SV-F336</b>	170x170		1	10



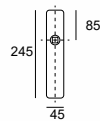

Ref.	mm	INOX		
<b>SV-G336</b>	60x32		4	80



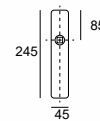
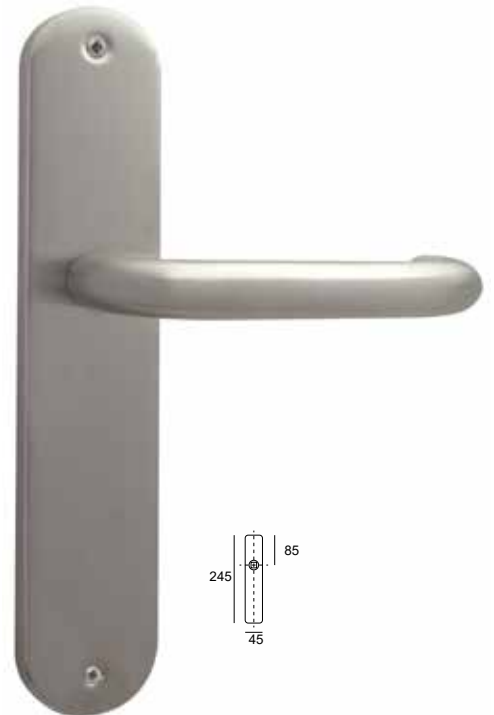

Ref.	INOX		
<b>SV-P336</b>		1	20





Ref.	INOX		
<b>SV-P337</b>		1	20





Ref.	mm	INOX	NE	PVLM		
<b>SV-R338</b>	Ø 52				1	40





Ref.	mm	INOX		
<b>SV-X338</b>	60x32		1	40





Ref.	mm	INOX		
<b>SV-G338</b>	60x32		4	80

El INOX, elevada  
resistencia a la corrosión



Ref.	INOX		
<b>SV-P338</b>		1	20



Ref.	INOX	NE		
<b>SV-P339</b>			1	20



Ref.	mm	INOX		
<b>SV-R318</b> MACIZA	Ø 52		1	20
<b>SV-R358</b> HUECA	Ø 52		1	40

NEW

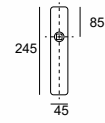

Ref.	INOX		
<b>SV-P318</b>		1	20

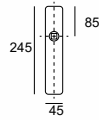

Ref.	INOX		
<b>SV-P319</b>		1	20

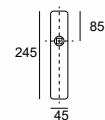

Ref.	INOX		
<b>SV-P334</b>		1	20



Ref.	mm	INOX		
<b>SV-C334</b>	50x50		1	40





NEW

Ref.	mm	INOX		
<b>SV-R258</b>	Ø 52		1	20



NEW

Ref.	mm	INOX		
<b>SV-C413</b>	53x53		1	20



NEW

Ref.	INOX		
<b>SV-P258</b>		1	20



NEW

Ref.	INOX		
<b>SV-P413</b>		1	20





Ref.	mm (entre cent.)	INOX	NE	
SV-M302	150		-	4
	200		-	4
	250		-	4
	300		-	4



Ref.	mm (entre cent.)	INOX	
SV-M318	200		4



Ref.	mm (entre cent.)	INOX	NE	PVLM	
SV-M338	150		-	-	1
	200				1



NEW

Ref.	mm (entre cent.)	INOX	
SV-M258	200		1



Ref.	mm (entre cent.)	INOX	
SV-M365	200		1



Ref.	mm (entre cent.)	INOX	NE	
SV-M360 (20x20)	200			2
	250			2
	300			2
	400			2
	450			2

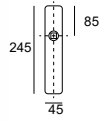

Ref.	INOX	NE	
<b>SV-MP32</b>			2

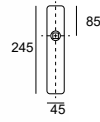

Ref.	INOX	NE	
<b>SV-PP32</b>			2



Ref.	INOX	NE	
<b>SV-LP30</b>			2



Ref.	mm	INOX	
<b>SV-MF32</b>	170x170		2



Ref.	mm	INOX	
<b>SV-LF30</b>	170x170		5

# MANILLONES GRAN FORMATO



NEW

Ref.	A (B)	INOX	
<b>EQ-M861</b> ■ 25 x 25 mm Desplazado 45°	400 (210)		1
	500 (300)		1
	600 (400)		1
	700 (500)		1
	800 (600)		1
	1200 (900)		1

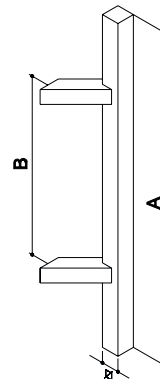



JANDEL INOX



NEW

Ref.	A (B)	INOX	
<b>EQ-M851</b> 40 x 10 mm	400 (210)		1
	500 (300)		1
	600 (400)		1
	800 (600)		1
	1200 (900)		1
	1500 (1300)		1

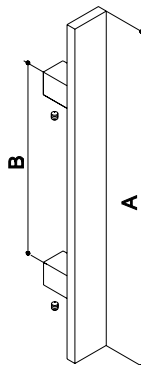

# MANILLONES GRAN FORMATO



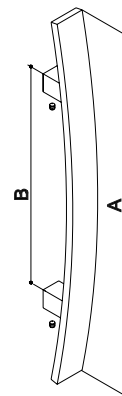

NEW

Ref.	A (B)	INOX	
<b>EQ-M841</b> 40 x 10 mm	500 (300)		1
	600 (400)		1
	800 (600)		1





Ref.	mm (entre cent.)	INOX	
<b>EQ-M800</b> (Ø30)	300 (210)		2
	400 (300)		2
	500 (300)		2
	600 (400)		2
	800 (600)		2
	1200 (900)		2
	1500 (1300)		1
	1800 (1500)		1

Ref.	mm (entre cent.)	INOX	
<b>EQ-M810</b> (Ø30) Desplazado 45°	300 (210)		2
	400 (300)		2
	500 (300)		2
	600 (400)		2
	800 (600)		2
	1200 (900)		2

Ref.	mm (entre cent.)	INOX	
<b>EQ-M831</b> (■ 25)	300 (210)		2
	400 (300)		2
	500 (300)		2
	600 (400)		2
	800 (600)		2
	1200 (900)		2
	1500 (1300)		1
	1800 (1500)		1



\* Medidas especiales consultar con el departamento comercial



Ref.	mm (entre cent.)	INOX	
<b>EQ-M801</b> (Ø 25)	425 (400)		2
	625 (600)		2

Ref.	mm (entre cent.)	INOX	
<b>EQ-M802</b> (Ø 25)	225 (200)		2
	325 (300)		2
	625 (600)		2
	925 (900)		2
	1225 (1200)		2

Ref.	mm (entre cent.)	INOX	
<b>EQ-M802K</b> (■ 25)	225 (200)		2
	325 (300)		2
	625 (600)		2
	925 (900)		2
	1225 (1200)		2



Ref.	mm	INOX	
<b>SV-340</b>	Ø 35		1



Ref.	mm	INOX	PVLM	
<b>SV-345</b>	Ø 50			1



Ref.	mm	INOX	
<b>SV-B309</b>	Ø 35		20



Ref.	mm	INOX	
<b>SV-348</b>	Ø 50		1



Ref.	mm	INOX	NE	PVLM	
<b>SV-B304</b>	Ø 50				20



Ref.	mm	INOX	NE	
<b>SV-B305</b>	Ø 50			20



Ref.	mm	INOX	
<b>SV-B307</b>	Ø 50		20



Ref.	mm	INOX	
<b>SV-346</b>	35 x 35		1



Ref.	mm	INOX	
<b>SV-347</b>	50 x 50		1



Ref.	mm	INOX	NE	
<b>SV-B303</b>	50 x 50			20



Ref.	mm	INOX	NE	
<b>SV-B308</b>	50 x 50			20



Ref.	mm	INOX	NE	
<b>SV-B306</b>	60 x 32			20



Ref.	INOX	
<b>SV-1198</b>		20



Ref.	mm	INOX	
<b>HUELLA15</b>	15 x 26		25



Ref.	mm	INOX	
<b>HUELLA20</b>	20 x 28		25



Ref.	mm	INOX	
<b>TOPE INOX</b>	22x30		25

JANDEL INOX





Ref.	mm	INOX	
<b>SV-8510</b>	Ø56 (Ø48 interior)		1





Ref.	mm	INOX	
<b>SV-8610</b>	Ø56 (Ø48 interior)		1



Ref.	mm	INOX	NE		
<b>SV-170P</b>	70 x 70			1	48



Ref.	mm	INOX		
<b>SV-172P</b>	Ø 85		1	48

JANDEL INOX



Ref.	mm	CB	CM	NM	BL	NE
<b>M04A</b>	45X20					



Ref.	mm	CM	NM
<b>M27A</b>	25X25	0.90	1.17



Ref.	mm	CM	NM
<b>M26A</b>	34X30		
<b>M26B</b>	25X21		



Ref.	mm	CM	NM
<b>M28A</b>	Ø 32	2.29	2.62

Ref.	mm	CM	NM
<b>M03A</b>	192		



Ref.	mm	CM	NM
<b>M07A</b>	128		



Ref.	mm	CB	CM	NM
<b>M09A</b>	128			
<b>M09B</b>	96			



Ref.	mm	CM	NM	NE
M10A	192			
M10B	128			



Ref.	mm	CM	NM
M12A	192		
M12B	160		
M12C	128		



Ref.	mm	CM	NM
M11A	192		
M11B	128		



Ref.	mm	CM	NM	BL	NE
M13A	240				
M13B	160				
M13C	128				



Ref.	mm	CM	NM
M14A	320		
M14B	224		
M14C	128		
M14D	96		
M14E	64		



Ref.	mm	CM	NM
M22A	256		
M22B	160		
M22C	128		



Ref.	mm	NM
M23A	792 / Ø12	
M23B	692 / Ø12	
M23C	592 / Ø12	
M23D	492 / Ø12	
M23E	442 / Ø12	
M23F	392 / Ø12	
M23G	342 / Ø12	
M23H	292 / Ø12	
M23I	242 / Ø12	
M23J	192 / Ø12	
M23K	160 / Ø12	
M23L	128 / Ø12	
M23M	96 / Ø12	



Ref.	mm	CM	NM
M24A	128		
M24B	96		
M24C	64		



Ref.	mm	CM	NM
M25A	128		



Ref.	mm	CM	NM
M29A	128		





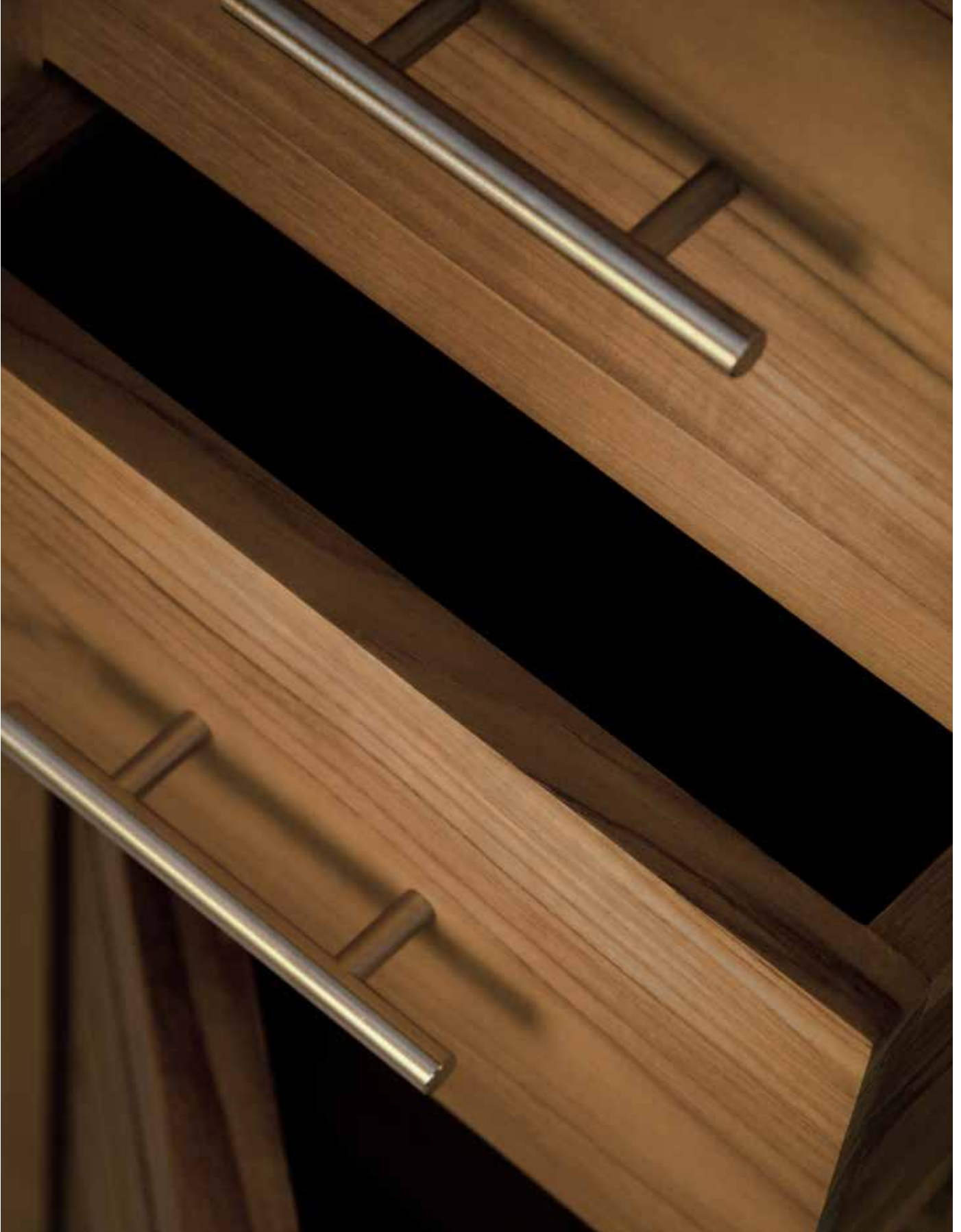



Ref.	mm	CU	CM
H55A	34x28		
H55B	22x22		



Ref.	mm	CU	CB	CM
H95A	47x47			
H95B	37x37			



Ref.	mm	CU	CM
H76A	24x21		



Ref.	mm	CU	CB	CM	PL
H102A	37x37				



Ref.	mm	CU	CM	PL
H93A	37x26			
H93B	25x18			



Ref.	mm	CU	CB	CM	PL
H103A	23x23				



Ref.	mm	CU	CM	PL
H94A	96			

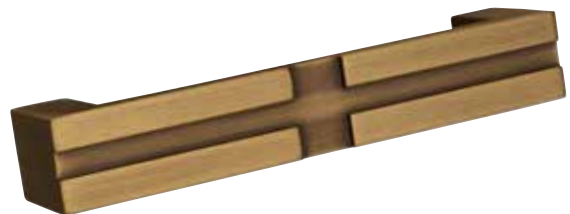

Ref.	mm	CU	PL
H113A	128		





Ref.	mm	CU	CB	CM	PL
<b>H107A</b>	Ø41 (32 entre centros)				



Ref.	mm	CU	CB	CM	PL
<b>H115A</b>	140x28 (96 entre centros)				



Ref.	mm	CU	CB	CM	PL
<b>H108A</b>	Ø78 (64 entre centros)				



Ref.	mm	CU	PL
<b>H120A</b>	96		



Ref.	mm	CU	CB	CM	PL
<b>H111A</b>	96				



Ref.	mm	CU	PL
<b>H121A</b>	50x50		



Ref.	mm	CU	CB	CM	PL
<b>H112A</b>	64				



Ref.	mm	CU	PL
<b>H122A</b>	35x35		



Ref.	mm	CU	CB	CM	PL
H123A	Ø62				



Ref.	mm	CU	CB	CM	PL
H124A	Ø50				



Ref.	mm	CU	CB	CM	PL
H125A	Ø28				





Ref.	mm	CU	PL
H126	50x50		



Ref.	mm	CU	PL
H127	35x35		



Ref.	mm	CU	PL
H128	22x22		





Ref.	mm	CU	PL
H129	68x68		



Ref.	mm	CU	CB	PL
H132	58x58			



Ref.	mm	CU	PL
H130	50x50		



Ref.	mm	CU	CB	PL
H133	45x45			



Ref.	mm	CU	PL
H131	40x40		



Ref.	mm	CU	CB	PL
H134	37x37			



Ref.	mm	CU	CB	PL
H135	28x28			



Ref.	mm	CM
<b>H136</b>	250 (128 entre centros)	



Ref.	mm	CM
<b>H137</b>	180 (128 entre centros)	



Ref.	mm	CM
<b>H138</b>	110 (64 entre centros)	



Ref.	mm	CB	CM
<b>H140</b>	64 (entre centros)		



Ref.	mm	NS
<b>SV-HUELLA</b>	Ø20	



## Leyenda de acabados



**PB** Pulido Brillo



**LM** Latón Mate



**EFLM** Efecto Latón Mate



**CU** Cuero



**CI** Cuero Inglés



**PS** Pulido Satinado



**NM** Níquel Mate



**CB** Cromo Brillo



**CS** Cromo Satinado



**PL** Plata



**CC** Cromo Combinado



**EFCS** Efecto Cromo Satinado



**ANTR** Antracita



**NM.OP** Níquel Mate Opaco



**CO.ST** Cobre Satinado



**AN** Anticato



**MR** Marrón



**NMM** Níquel Mate Mate



**NS** Níquel Satinado



**NS/NB** Níq. Satin./Níq. Brillo



**INOX**



**NE** Negro



**BL** Blanco



**PVLM** PVD Latón Mate



**PL. AN** Plata Anodizada

¡ Hasta pronto !

[www.jandel.es](http://www.jandel.es)



# S SOLANELLAS

FERRETERIA I CUINES

Ctra. de Rubí, 304 · 08228 Terrassa (Barcelona) · Tel 93 731 73 12

PREFABRICATS

C/. Pisuerga, 30 · 08223 Terrassa (Barcelona) · Tel 93 731 73 11

[www.solanellas.com](http://www.solanellas.com)

